



Service Manual

Models: GWH09KF-K3DNA6G/I
GWH12KF-K3DNA6G/I
(Refrigerant R410A)

Table of Contents

Part I : Technical Information	1
1. Summary	1
2. Specifications	2
2.1 Specification Sheet.....	2
2.2 Noise Curve.....	3
3. Outline Dimension Diagram	4
4. Refrigerant System Diagram	5
5. Electrical Part	6
5.1 Wiring Diagram.....	6
5.2 PCB Printed Diagram.....	7
6. Function and Control	8
6.1 Remote Controller Introduction.....	8
6.2 Brief Description of Modes and Functions.....	12
Part II : Installation and Maintenance	16
7. Notes for Installation and Maintenance	16
8. Installation	18
8.1 Installation Dimension Diagram.....	18
8.2 Installation Parts-checking.....	20
8.3 Selection of Installation Location.....	20
8.4 Electric Connection Requirement.....	20
8.5 Installation of Indoor Unit.....	20
8.6 Check after Installation and Test Operation.....	23
9. Maintenance	24
9.1 Flashing LED of Indoor/Outdoor Unit and Primary Judgement.....	24
9.2 Procedure of Troubleshooting.....	32
9.3 Maintenance Method for Normal Malfunction.....	37
10. Exploded View and Parts List	39

11. Removal Procedure 41

Appendix: 55

Appendix 1: Reference Sheet of Celsius and Fahrenheit 55

Appendix 2: Configuration of Connection Pipe..... 55

Appendix 3: Pipe Expanding Method 56

Appendix 4: List of Resistance for Temperature Sensor 57

Part I : Technical Information

1. Summary

Indoor Unit:

GWH09KF-K3DNA6G/I
GWH12KF-K3DNA6G/I

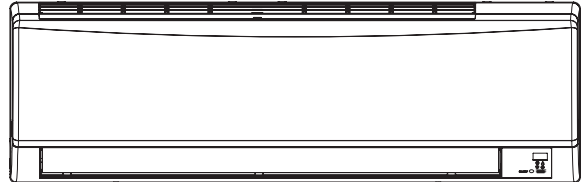

Remote Controller:

YB1F2(XFAN)



2. Specifications

2.1 Specification Sheet

Model		GWH09KF-K3DNA6G/I	GWH12KF-K3DNA6G/I
Product Code		CB146N36200	CB146N36100
Rated Voltage	V~	220-240	220-240
Rated Frequency	Hz	50	50
Phases		1	1
Power Supply Mode		Outdoor	Outdoor
Cooling Capacity(Min~Max)	W	2600(450~3230)	3500(450~3230)
Heating Capacity(Min~Max)	W	2800(450~4100)	3800(450~4100)
Cooling Power Input(Min~Max)	W	870(200~1420)	1150(200~1420)
Heating Power Input(Min~Max)	W	900(200~1550)	1100(200~1550)
Air Flow Volume (SH/H/M/L)	m ³ /h	600/520/370/280	680/560/410/300
Dehumidifying Volume	L/h	0.8	1.4
Fan Type		Cross-flow	Cross-flow
Fan Diameter-height	mm	Φ92X596	Φ92X596
Fan Motor Speed (SH/H/M/L) Cool	rpm	1350/1100/900/700	1350/1150/950/750
Fan Motor Speed (SH/H/M/L) Heat	rpm	1350/1140/980/820	1350/1190/1020/850
Fan Motor Power Output	W	10	10
Fan Motor Running Current	A	0.18	0.18
Fan Motor Capacitor	μF	1.2	1.2
Evaporator Material		Aluminum Fin-copper Tube	Aluminum Fin-copper Tube
Evaporator Pipe Diameter	mm	Φ7	Φ7
Evaporator Number of Rows		2	2
Evaporator Fin Pitch	mm	1.4	1.4
Evaporator Length(L)XHeight(H)XWidth(W)	mm	610X24X294	610X24X294
Motor Model		MP24BA	MP24BA
Overload Protector		/	/
Motor Full Load Amp(FLA)	A	3.15	3.15
Sound Pressure Level (SH/H/M/L)	dB (A)	41/38/30/24	42/39/31/25
Sound Power Level (SH/H/M/L)	dB (A)	55/52/44/38	56/53/45/39
Outline Dimension (WXHXD)	mm	770X283X201	770X283X201
Package Carton Dimension (LXWXH)	mm	844X342X261	844X342X261
Package Dimension (LXWXH)	mm	847X345X276	847X345X276
Net Weight	kg	8	9
Gross Weight	kg	9.5	10.5
Liquid pipe	mm	Φ6	Φ6
Gas Pipe(to indoor unit)	mm	Φ9.52	Φ9.52

Note: The connection pipe applies metric diameter.

The above data is subject to change without notice; please refer to the nameplate of the unit.

2.2 Noise Curve

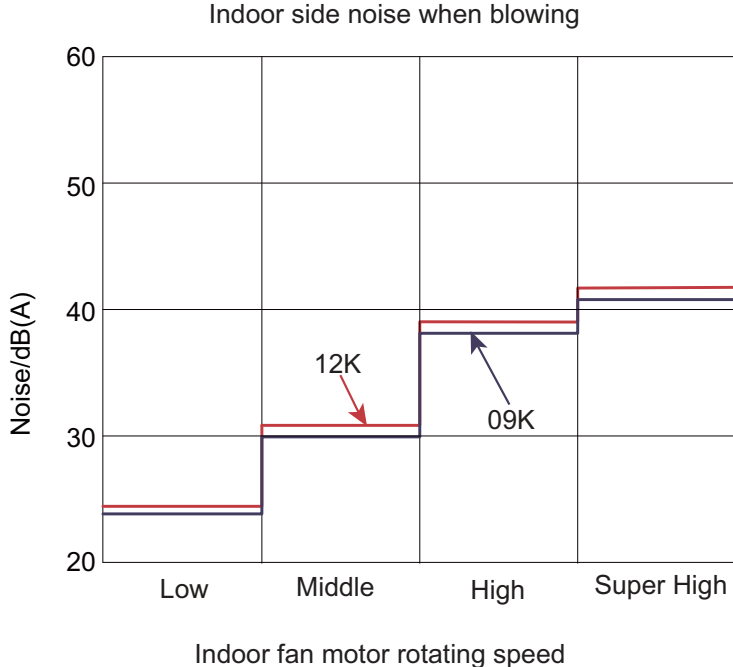

3. Outline Dimension Diagram

Indoor Unit

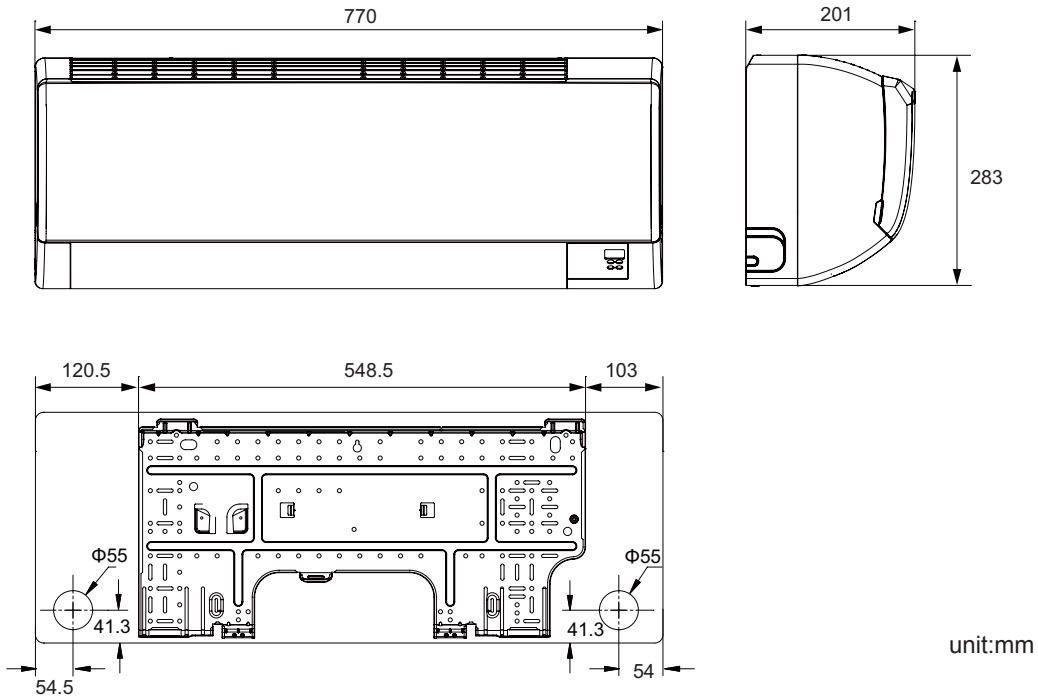

4. Refrigerant System Diagram

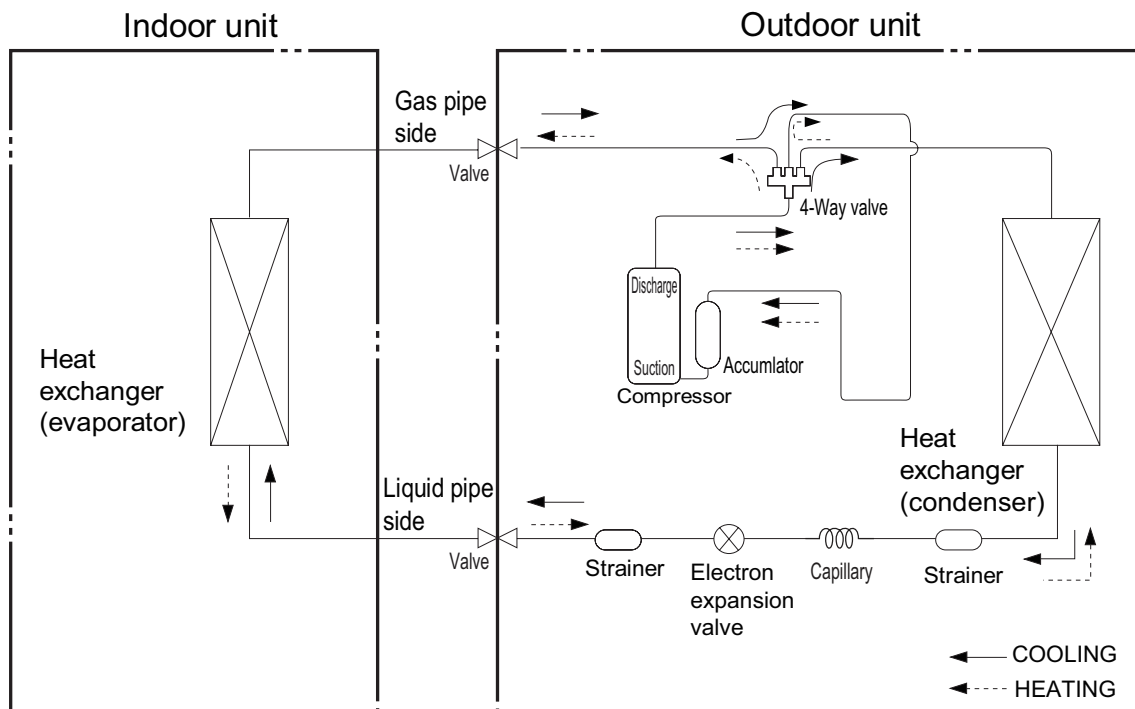

Connection pipe specification:
 Liquid pipe: 1/4" (6mm)
 Gas pipe: 3/8" (9.52mm)

5. Electrical Part

5.1 Wiring Diagram

• Instruction

Symbol	Symbol Color	Symbol	Symbol Color	Symbol	Name
WH	White	GN	Green	CAP	Jumper cap
YE	Yellow	BN	Brown	COMP	Compressor
RD	Red	BU	Blue	⊕	Grounding wire
YEGN	Yellow/Green	BK	Black	/	/
VT	Violet	OG	Orange	/	/

Note: Jumper cap is used to determine fan speed and the swing angle of horizontal lover for this model.

• Indoor Unit

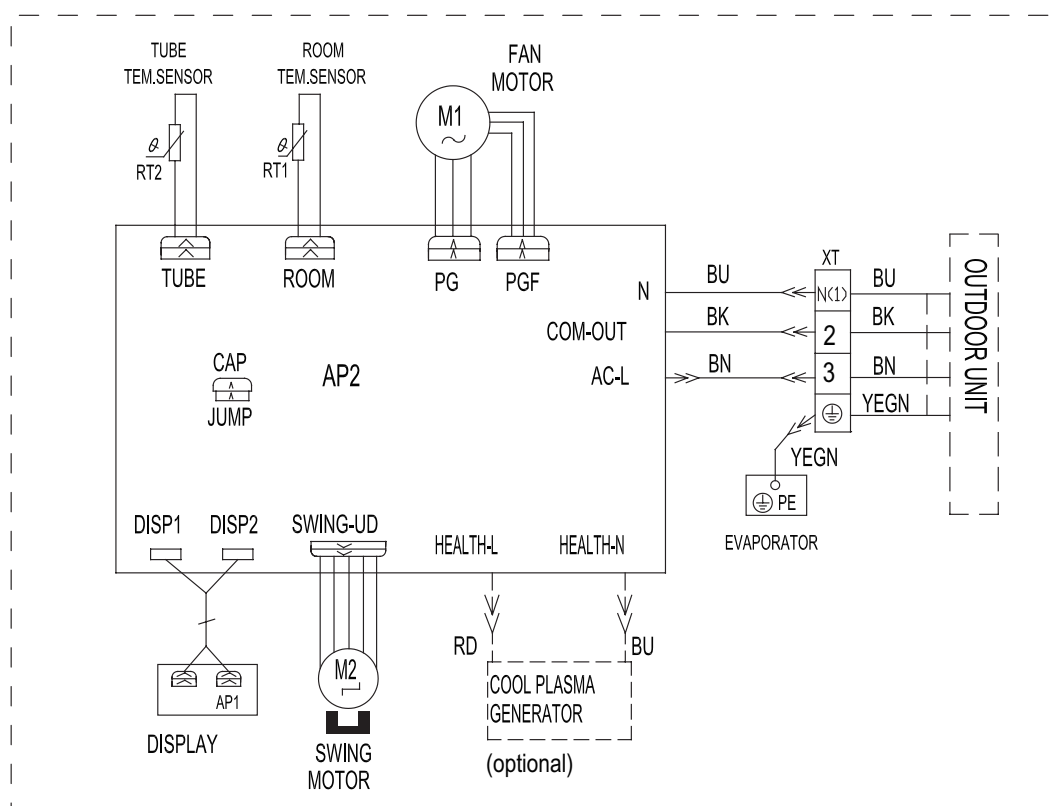

These wiring diagrams are subject to change without notice; please refer to the one supplied with the unit.

5.2 PCB Printed Diagram

Indoor Unit

•TOP VIEW

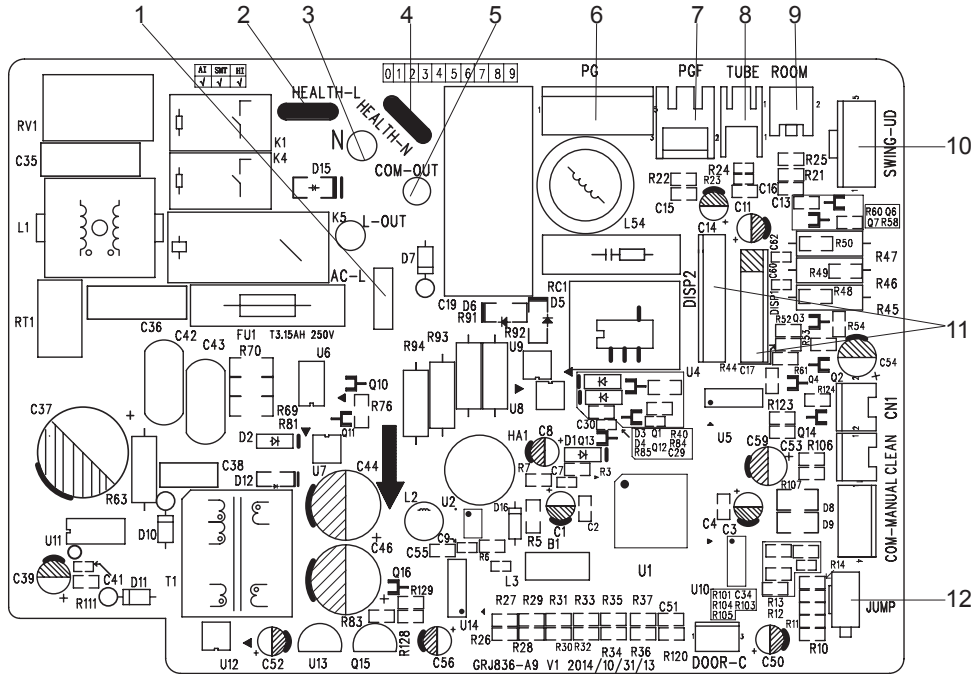

No.	Name
1	Interface of live wire
2	Interface of live wire for health function
3	Interface of neutral wire
4	Interface of neutral wire for health function
5	Interface of neutral wire and live wire communication
6	Control interface of PG motor
7	Feedback interface of indoor fan
8	Indoor tube temperature sensor interface
9	Ambient temperature sensor interface
10	Up & down swing
11	Interface of display
12	Jumper cap

•BOTTOM VIEW

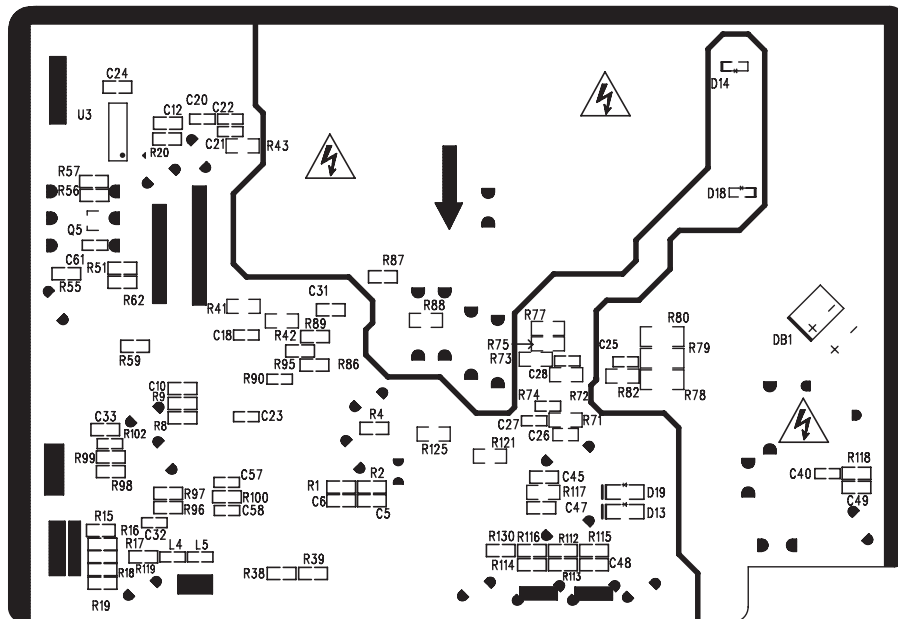

6. Function and Control

6.1 Remote Controller Introduction

Buttons on remote controller

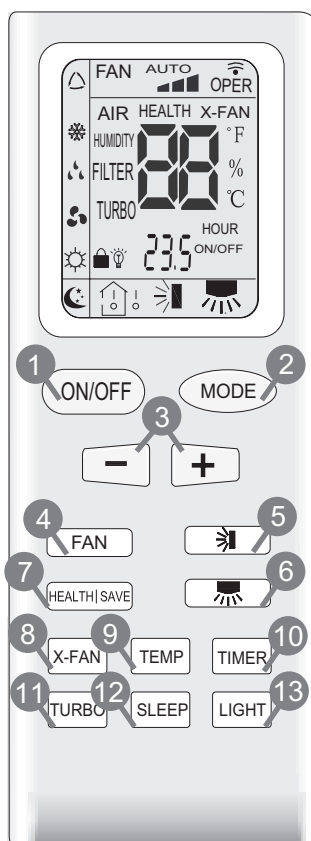

- ① ON/OFF Button
- ② MODE Button
- ③ +/- Button
- ④ FAN Button
- ⑤ Button
- ⑥ Button
- ⑦ HEALTH|SAVE Button
- ⑧ X-FAN Button
- ⑨ TEMP Button
- ⑩ TIMER Button
- ⑪ TURBO Button
- ⑫ SLEEP Button
- ⑬ LIGHT Button

Introduction for icons on display screen

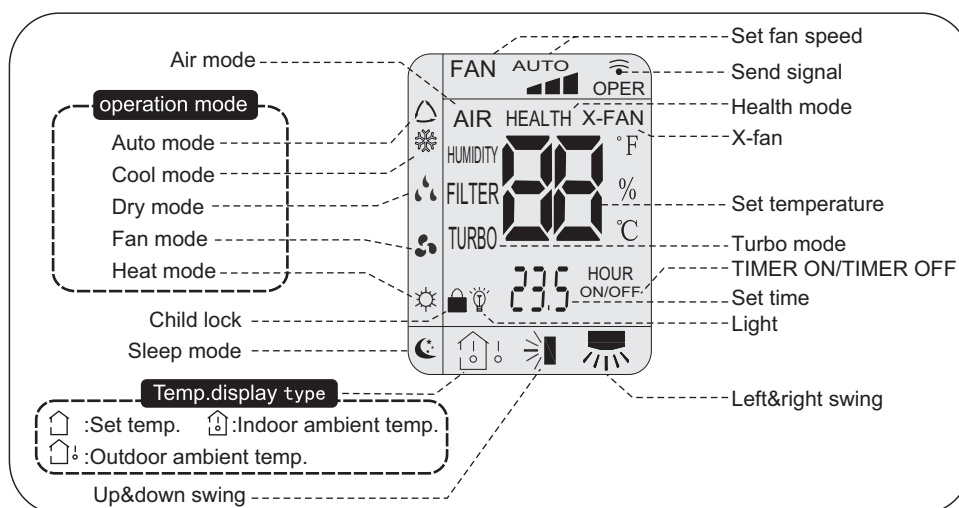

Introduction for buttons on remote controller

Note:

- After putting through power, air conditioner will give out a sound and operation indicator "⏻" is ON (red indicator). You can operate the air conditioner through the remote controller.
- At ON status, after each pressing button on remote controller, the signal icon "📶" on remote controller will flash once. Air conditioner will give out a sound, which indicates the signal has been sent to air conditioner.
- At OFF status, display screen on remote controller displays set temperature. At on status, display screen on remote controller displays the corresponding start up function's icon.

1.ON/OFF button

Press this button can turn on or turn off the air conditioner. After turning on the unit,operation indicator "⏻" on indoor unit is ON (green indicator. Color may be differ-ent for different models)and indoor unit gives out a sound.

2.MODE button

Press this button can select your required operation mode.



- After selecting auto mode, air conditioner will operate automatically according to ambient temperature. Set temperature can't be adjusted and also can't be displayed. Press "FAN" button can adjust fan speed. Press "↔" button can adjust swing angle.
- After selecting cool mode, air conditioner operates under cool mode. Cool indicator "❄️" on indoor unit is ON. You can press "+" or "-" button to adjust set temperature. Press "FAN" button can adjust fan speed. Press "↔" button can adjust swing angle.
- After selecting dry mode, air conditioner operates under dry mode at low speed. Dry indicator "💧" on indoor unit is ON. Under dry mode, fan speed can't be adjusted. Press "↔" button to adjust swing angle.
- After selecting fan mode, air conditioner operates only under fan mode, All mode indicators on indoor unit is OFF. Operation indicator is ON. Press "FAN" button can adjust fan speed. Press "↔" button to adjust swing angle.
- After selecting heat mode, air conditioner operates under heat mode. Heat indicator "☀️" on indoor unit is ON. You can press "+" or "-" button to adjust set temperature. Press "FAN" button to adjust fan speed. Press "↔" button to adjust swing angle. (Cooling only unit can't receive the signal for heating mode.)

Note:

For preventing cold wind, after starting up heating mode, indoor fan will blow fan afterdelaying 1-5min. (Details time is decided by indoor ambient temperature) Temperature setting range on remote controller: 16°C~30°C(61°F~86°F) . Fan speed setting range: auto, low speed, medium speed and high speed.

3."+" or "-" button

- After each pressing of "+" or "-" button, it can increase or decrease set temperature 1°C(1°F~2°F) . Hold "+" or "-" button, 2s later, set temperature on remote controller will change quickly. After reaching to your required time, loosen the button. Temperature indicator on indoor unit will also change accordingly. (Temperature can't be adjusted under auto mode)
- Under TIMER ON, TIMER OFF or Clock setting, you can press "+"or "-" button to adjust time. (Refer to TIMER button for details)

4.FAN button

Pressing this button can set fan speed circularly as: auto (AUTO), low(📶), medium(📶📶), high(📶📶📶).



Note:

- Under AUTO Speed, IDU fan motor will adjust the fan speed (high, medium or low speed) according to ambient temperature.
- Fan speed under dry mode is low speed.

5.↔ button

- Press this button to start or stop up & down swing function.The remote controller defaults to simple swing condition.
- Press "+" button and "↔" button at the same time at unit OFF to switch between simple swing and static swing; "↔" blinks for 2 seconds.
- In static swing condition, pressing "↔" button, the swing angle of up & down louver changes as below:

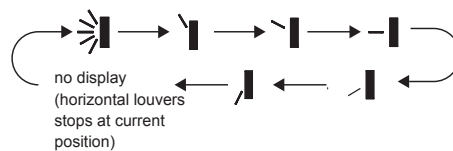

- If the unit is turned off during swing operation,the louver will stop at present position.

Note:

When selecting "↔" with remote controller, it's auto swing. Horizontal louver of air conditioner will swing up&down automatically at the maximum angle.

When selecting "↖", "↗", "↘", "↙", "↕" with remote controller, it is the fixed position swing. Horizontal louver of air conditioner will stop at that position as shown by the icon to swing.

6.📶 button

- Press this button to start or stop left & right swing function. The remote controller defaults to simple swing condition.
- Press "+" button and "📶" button at the same time at unit OFF to switch between simple swing and static swing; blinks for 2 seconds.
- In static swing condition, pressing "📶" button, the swing angle of left & right louver changes as below:

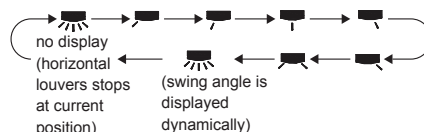

- If the unit is turned off during swing operation, the louver will stop at present position.
- When selecting "🏠", "🏠", "🏠", "🏠", "🏠" with remote controller, it is the fixed position swing. Horizontal louver of air conditioner will stop at that position as shown by the icon to swing.
- When selecting "(🏠_{swing angle is displayed dynamically})" it's the circulating swing. Horizontal louver of air conditioner will swing circularly according to the angle as shown by the icon.

Note:

There is no this function for the units. If press this key, the main unit will click, but it also runs under original status.

7.HEALTH/SAVE button

- After pressing HEALTH button, remote controller will switch circularly as below: "HEALTH"→"AIR"→"AIR HEALTH"→"no display"
- When selecting "HEALTH" by remote controller, HEALTH function will be started up.
- When selecting "AIR" by remote controller, AIR function will be started up.
- When selecting "AIT HEALTH", AIR and HEALTH function will be started up.
- When there's no display on remote controller, AIR and HEALTH function will be turned off.
- AIR function is applicable for some models.

SAVE function:

- Under cool mode, press SAVE button and the unit will operate under SAVE mode. Dual-8nixe tube on remote controller displays "SE". Air conditioner will operate at auto speed. Set temperature can't be adjusted. Press SAVE button again to exit SAVE mode. Air conditioner turn back to original set speed and set temperature.
- This function is applicable to partial of models.

8.X-FAN button

After pressing this button under cooling or dry mode, remote controller displays the character of "X-FAN" and X-FAN function is started up. Press this button again to cancel X-FAN function. The character of "X-FAN" will disappear.

Note:

- After starting up X-FAN function, when turning off the unit, indoor fan will continue to operate for a while at low speed to dry the residual water inside the indoor unit.
- When the unit operates under X-FAN mode, press "X-FAN" button can turn off X-FAN function. Indoor fan stops operation immediately.

9.TEMP button

Press this button can see indoor set temperature, indoor ambient temperature or outdoor ambient temperature on indoor unit's display. Temperature is set circularly by remote controller as below:



- When selecting "🏠" by remote controller or no display, temperature indicator on indoor unit displays set temperature.
- When selecting "🏠☀️" by remote controller, temperature indicator on indoor unit displays indoor ambient temperature.
- When selecting "🏠☀️❄️" by remote controller, temperature indicator on indoor unit displays outdoor ambient temperature.

Note:

- Outdoor ambient temperature display may can't be selected for some models. When indoor unit receives "🏠☀️❄️" signal, it displays indoor set temperature.
- Only for the model whose indoor unit has dual-8 display.

10.TIMER button

At ON status, press this button once can set TIMER OFF. The character of HOUR and OFF will flash. Press "+" or "-" button within 5s can adjust the time of TEMER ON. After each pressing of "+" or "-" button, time will increase or decrease half an hour. When holding "+" or "-" button, 2s later, the time will change quickly until to reach to your required time. After that, press "TIMER" button to confirm it. The character of HOUR and OFF won't flash again.

Cancel TIMER OFF: Press "TIMER" button again under TIMER OFF status.

At OFF status, press this button once can set TIMER ON. Please refer to TIMER off for detailed operation.

Cancel TIMER ON: Press "TIMER" button again under TIMER ON status.

Note:

- Time setting range: 0.5-24 hours.
- Time interval between two operations can't exceed 5s. Otherwise, remote controller will exit the setting status automatically.

11.TURBO button

When pressing this button under cooling or heating mode, air conditioner will enter into quick cooling or quick heating mode. The character of "TURBO" is displayed on remote controller. Press this button again to exit turbo function and the character of "TURBO" will be disappeared on remote controller.

12.SLEEP button

Press this button under cooling, heating mode can start up sleep function. "🌙" icon will be displayed on remote controller. Press this button again to cancel sleep function. "🌙" icon on remote controller will be displayed.

13.LIGHT button

Press this button can turn off the light for indoor unit's display. "🌙" icon on remote controller will disappear. Press this button again to turn on the light for indoor unit's display. "🌙" icon on remote controller will be displayed.

Function introduction for combination buttons

Child lock function

Press "+" and "-" buttons simultaneously can turn on or turn off child lock function. When child lock function is started up, "🔒" icon will be displayed on remote controller. If operate remote controller "🔒" icon will flash three times, while remote controller won't send signal.

Switchover function for temperature display

After turning off the unit by remote controller, press "-" button and "MODE" button simultaneously to switch between °C and °F.

Operation guide

1. After putting through the power, press "ON/OFF" button on remote controller to turn on the air conditioner.
2. Press "MODE" button to select your required mode: AUTO, COOL, DRY, FAN, HEAT.
3. Press "+" or "-" button to set your required temperature. (Temperature can't be adjusted under auto mode).
4. Press "FAN" button to set your required fan speed: auto, low, medium and high speed.
5. Press "↻" button to select fan blowing angle.

Replacement of batteries in remote controller

1. Press the back side of remote controller marked with "OPEN", as shown in the fig, and then push out the cover of battery box along the arrow direction.
2. Replace two 7# (AAA 1.5V) dry batteries, and make sure the position of "+" polar and "-" polar are correct.
3. Reinstall the cover of battery box.

NOTICE

- During operation, point the remote control signal sender at the receiving window on indoor unit.
- The distance between signal sender and receiving window should be no more than 8m, and there should be no obstacles between them.
- Signal may be interfered easily in the room where there is fluorescent lamp or wireless telephone; remote controller should be close to indoor unit during operation.
- Replace new batteries of the same model when replacement is required.
- When you don't use remote controller for a long time, please take out the batteries.

If the display on remote controller is fuzzy or there's no display, please replace batteries.

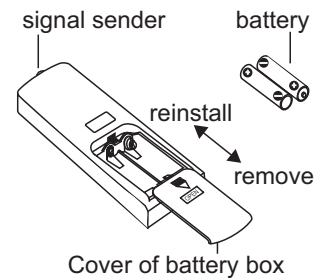

6.2 Brief Description of Modes and Functions

1. Temperature Parameters

- Indoor preset temperature (T_{preset})
- Indoor ambient temperature (T_{amb})

2. Basic Functions

Once energized, in no case should the compressor be restarted within less than 3 minutes. In the situation that memory function is available, for the first energization, if the compressor is at stop before de-energization, the compressor will be started without a 3-minute lag; if the compressor is in operation before de-energization, the compressor will be started with a 3-minute lag; and once started, the compressor will not be stopped within 6 minutes regardless of changes in room temperature;

(1) COOL mode

① The condition and process of cooling

If $T_{\text{amb}} \geq T_{\text{preset}}$ COOL mode will act, the compressor and outdoor fan will run, and the indoor fan will run at the set speed.

If $T_{\text{amb}} \leq T_{\text{preset}} - 2^{\circ}\text{C}$, the compressor will stop, the outdoor fan will delay 30 seconds to stop, and the indoor fan will run at the set speed. If $T_{\text{preset}} - 2^{\circ}\text{C} \leq T_{\text{amb}} \leq T_{\text{preset}}$, the unit will keep running in the previous mode. In this mode, the reversal valve will not be powered on and the temperature setting range is $16 \sim 30^{\circ}\text{C}$.

② Protection function

- Overcurrent protection

If total current is high, the compressor will run in limited frequency. If total current is too high, the compressor will stop, the outdoor fan will delay 30 seconds to stop, indoor unit will display E5 and outdoor yellow light will blink 5 times.

- Antifreezing protection

When the antifreezing protection is detected, the compressor will stop, the outdoor fan will stop after 30 seconds, and the indoor fan and swing motor will keep running in the original mode. When antifreezing protection is eliminated and the compressor has stopped for 3 minutes, the compressor will resume running in the original mode.

(2) Dehumidifying mode

① Working conditions and process of dehumidifying

If $T_{\text{amb}} > T_{\text{preset}}$, the unit will enter cooling and dehumidifying mode, in which case the compressor and the outdoor fan will operate and the indoor fan will run at low speed.

If $T_{\text{preset}} - 2^{\circ}\text{C} \leq T_{\text{amb}} \leq T_{\text{preset}}$, the compressor remains at its original operation state.

If $T_{\text{amb}} < T_{\text{preset}} - 2^{\circ}\text{C}$, the compressor will stop, the outdoor fan will stop with a time lag of 30s, and the indoor fan will operate at low speed.

② Protection function

Protection is the same as that under the cooling mode.

(3) HEAT mode

① The condition and process of heating

If $T_{\text{amb}} \leq T_{\text{preset}} + 2^{\circ}\text{C}$, HEAT mode will act, the compressor, outdoor fan and reversal valve will run, the indoor fan will delay 3min to stop at the latest.

If $T_{\text{preset}} + 2^{\circ}\text{C} \leq T_{\text{amb}} \leq T_{\text{preset}} + 5^{\circ}\text{C}$, the unit will keep running in the original mode.

If $T_{\text{amb}} \geq T_{\text{preset}} + 5^{\circ}\text{C}$, the compressor will stop, the outdoor fan will delay 30sec to stop and indoor fan will blow 60S at low speed, the fan speed cannot be shifted within blow residual heat.

- In this mode, the temperature setting range is $16 \sim 30^{\circ}\text{C}$.

- The air conditioner will adjust the running frequency of the compressor automatically according to the change of ambient temperature.

- When the unit is turned off in HEAT mode, or switched to other mode from HEAT mode, the four-way valve will be powered off after the compressor stops.

② The condition and process of defrosting

When frost is detected in the condenser, the system will enter into defrosting state. When defrosting starts, the compressor and indoor fan will stop, and the outdoor fan and four-way valve will delay 30 seconds to stop. The compressor will start after 15 seconds and then defrosting will be started. When the compressor has run for 7 minutes or defrosting is finished, the compressor will stop. After 30 seconds the four-way valve opens and after another 60 seconds, the compressor and outdoor fan resume running. The indoor fan will delay 3 minutes to run at the latest and heating indicator on indoor unit OFF 0.5s and ON 10s.

③ Protection function

- Anti-cold-wind protection

In HEAT mode, in order to prevent the indoor unit from blowing out cold wind, each time the compressor starts, the indoor fan will delay 3 minutes after the compressor to run at the latest and it can adjust fan speed automatically when temperature is low.

- Overcurrent protection

Overcurrent protection is the same with that in COOL mode.

- Cold air prevention

The unit is started under heating mode (the compressor is ON):

1. In the case of $T_{\text{indoor amb.}} < 24^{\circ}\text{C}$: if $T_{\text{tube}} \leq 40^{\circ}\text{C}$ and the indoor fan is at stop state, the indoor fan will begin to run at low speed with a time lag of 2 minutes. Within 2 minutes, if $T_{\text{tube}} > 40^{\circ}\text{C}$, the indoor fan also will run at low speed; and after 1-minute operation at low speed, the indoor fan will be converted to operation at preset speed. Within 1-minute low speed operation or 2-minute non-operation, if $T_{\text{tube}} > 42^{\circ}\text{C}$, the fan will run at present speed.

2. In the case of $T_{\text{indoor amb.}} \geq 24^{\circ}\text{C}$: if $T_{\text{tube}} \leq 42^{\circ}\text{C}$, the indoor fan will run at low speed, and after one minute, the indoor fan will be converted to preset speed. Within one-minute low speed operation, if $T_{\text{tube}} > 42^{\circ}\text{C}$, the indoor fan will be converted to preset speed.

Note: $T_{\text{indoor amb.}}$ indicated in 1 and 2 refers to, under initially heating mode, the indoor ambient temperature before the command to start the compressor is performed according to the program, or after the unit is withdrawn from defrost, the indoor ambient temperature before the defrost symbol is cleared.

● Total current up and frequency down protection

If the total current $I_{\text{total}} \leq W$, frequency rise will be allowed; if $I_{\text{total}} \geq X$, frequency rise will not be allowed; if $I_{\text{total}} \geq Y$, the compressor will run at reduced frequency; and if $I_{\text{total}} \geq Z$, the compressor will stop and the outdoor fan will stop with a time lag of 30s.

(4) Fan Mode

Under the mode, the indoor fan will run at preset speed and the compressor, the outdoor fan, the four-way valve and the electric heater will stop.

Under the mode, temperature can be set within a range of $16 \sim 30^{\circ}\text{C}$.

(5) AUTO Mode

① The condition and process of auto

a. When $T_{\text{amb.}} \geq 26^{\circ}\text{C}$ the unit will operate at Cooling mode. In that case, the set temperature will be 25°C .

b. When $T_{\text{amb.}} \leq 22^{\circ}\text{C}$ the heat pump unit will operate at Heating mode. In that case, the set temperature will be 20°C ; the cooling-only unit will operate at Fan mode and the set temperature will be 25°C .

c. When $23^{\circ}\text{C} \leq T_{\text{amb.}} \leq 25^{\circ}\text{C}$ the unit will keep its operation status but if it is firstly energized, the unit will operate at Fan mode.

d. When unit operates at Auto mode, the frequency of compressor will be the same as that in Cooling mode if the unit is cooling while it will be the same as that in the Heating mode if the unit is heating.

② Protection function

a. In cooling operation, protection is the same as that under the cooling mode;

b. In heating operation, protection is the same as that under the heating mode;

c. When ambient temperature changes, operation mode will be converted preferentially. Once started, the compressor will remain unchanged for at least 6 minutes.

(6) Common Protection Functions and Fault Display under COOL, HEAT, DRY and AUTO Modes

① Overload protection

T_{tube} : measured temperature of outdoor heat exchanger under cooling mode; and measured temperature of indoor heat exchanger under heating mode.

1) Cooling overload

a. If $T_{\text{tube}} \leq 52$, the unit will return to its original operation state.

b. If $T_{\text{tube}} \leq 55$, frequency rise is not allowed.

c. If $T_{\text{tube}} \leq 58$, the compressor will run at reduced frequency.

d. If $T_{\text{tube}} \leq 62$, the compressor will stop and the indoor fan will run at preset speed.

2) Heating overload

a. If $T_{\text{tube}} \leq 52$, the unit will return to its original operation state.

b. If $T_{\text{tube}} \leq 55$, frequency rise is not allowed.

c. If $T_{\text{tube}} \leq 58$, the compressor will run at reduced frequency.

d. If $T_{\text{tube}} \leq 62$, the compressor will stop and the indoor fan will blow residue heat and then stop.

② Exhaust temperature protection of compressor

If exhaust temperature 98, frequency is not allowed to rise.

If exhaust temperature 103, the compressor will run at reduced frequency.

If exhaust temperature 110, the compressor will stop.

If exhaust temperature 90 and the compressor has stayed at stop for at least 3 minutes, the compressor will resume its operation.

③ Communication fault

If the unit fails to receive correct signals for durative 3 minutes, communication fault can be justified and the whole system will stop.

④ Module protection

Under module protection mode, the compressor will stop. When the compressor remains at stop for at least 3 minutes, the compressor will resume its operation. If module protection occurs six times in succession, the compressor will not be started again.

⑤ Overload protection

If temperature sensed by the overload sensor is over 115, the compressor will stop and the outdoor fan will stop with a time lag of 30 seconds.

⑥ If temperature is below 95, the overload protection will be relieved. If voltage on the DC bus is below 150V or over 420V, the compressor will stop and the outdoor fan will stop with a time lag of 30 seconds. When voltage on the DC bus returns to its normal value and the compressor has stayed at stop for at least 3 minutes, the compressor will resume its operation.

3. Other Controls

(1) ON/OFF

Press the remote button ON/OFF: the on-off state will be changed once each time you press the button.

(2) Mode Selection

Press the remote button MODE, then select and show in the following ways: AUTO, COOL, DRY, FAN, HEAT, AUTO.

(3) Temperature Setting Option Button

Each time you press the remote button TEMP+ or TEMP-, the setting temperature will be up or down by 1°C. Regulating Range: 16~30°C, the button is useless under the AUTO mode.

(4) Time Switch

You should start and stop the machine according to the setting time by remote control.

(5) SLEEP State Control

① Cooling mode

a. When initial temperature setting is 16~23°C, after turning on sleep function, temperature will increase 1°C every one hour. After temperature is increased by 3°C, the unit will keep this temperature. After operation for 7 hours, temperature will decrease 1°C. After that, the unit will operate at this temperature all the time.

b. When initial temperature setting is 24~27°C, after turning on sleep function, temperature will increase 1°C every one hour. After temperature is increased by 2°C, the unit will keep this temperature. After operation for 7 hours, temperature will decrease 1°C. After that, the unit will operate at this temperature all the time.

c. When initial temperature setting is 28~29°C, after turning on sleep function, temperature will increase 1°C every one hour. After temperature is increased by 1°C, the unit will keep this temperature. After operation for 7 hours, temperature will decrease 1°C. After that, the unit will operate at this temperature all the time. When the initial temperature setting is 30°C, the unit will operate under this temperature. After operation for 7 hours, temperature will decrease 1°C. After that, the unit will operate at this temperature all the time.

② Heating mode:

a. When initial temperature setting is 16°C, the unit operate under this temperature all the time.

b. When initial temperature setting is 17~20°C, after turning on sleep function, temperature will decrease 1°C every one hour. After temperature is increased by 1°C, the unit will keep this temperature.

c. When initial temperature setting is 21~27°C, after turning on sleep function, temperature will decrease 1°C every one hour. After temperature is increased by 2°C, the unit will keep this temperature.

d. When initial temperature setting is 28~30°C, after turning on sleep function, temperature will decrease 1°C every one hour. After temperature is increased by 3°C, the unit will keep this temperature.

(6) Indoor Fan Control

Speed of indoor fan can be set as Turbo, High, Med., Low by remote control. In that case, fan will operate at super high, high, medium, or low speed accordingly. The fan speed can also be set at Auto, which is as follows:

① In heating mode: in auto heating or heating mode, the auto fan speed is as follows:

a. $T_{amb} \leq T_{preset} + 1^\circ\text{C}$: indoor fan will operate at high speed;

b. $T_{preset} + 1^\circ\text{C} < T_{amb} < T_{preset} + 3^\circ\text{C}$: indoor fan will operate at med. speed;

c. $T_{amb} \geq T_{preset} + 3^\circ\text{C}$: indoor fan will operate at low speed; At least 210 seconds of operation shall be maintained for switchover between high and low speeds, med. and low speeds, and high and low speeds.

② In cooling mode, in auto cooling or cooling mode, the auto fan speed is as follows:

a. $T_{amb} \geq T_{preset} + 2^\circ\text{C}$: indoor fan will operate at high speed.

b. $T_{preset} < T_{amb} < T_{preset} + 2^\circ\text{C}$: indoor fan will operate at med. speed;

c. $T_{amb} \leq T_{preset}$: indoor fan will operate at low speed. At least 210 seconds of operation shall be maintained for switchover between high and low speeds, med. and low speeds, and high and low speeds.

(7) Buzzer Control

The buzzer will send a "Di" sound when the air conditioner is powered up or received the information sent by the remote control or there is a button input, the single tube cooler doesn't receive the remote control ON signal under the mode of heating mode.

(8) Auto button

If the controller is on, it will stop by pressing the button, and if the controller is off, it will be automatic running state by pressing the button, swing on and light on, and the main unit will run based on the remote control if there is remote control order.

(9) Up-and-Down Swinging Control

When power on, the up-and-down motor will firstly move the air deflector to 0 counter-clockwise, close the air outlet. After starting the machine, if you don't set the swinging function, heating mode and auto-heating mode, the up-and-down air deflector will move to D clockwise; under other modes, the up-and-down air deflector will move to L. If you set the swinging function when you start the machine, then the wind blade will swing between L and D. The air deflector has 7 swinging states: Location L, Location A, Location B, Location C, Location D, Location L to Location D, stop at any location between L-D (the included angle between L~D is the same). The air deflector will be closed at 0 Location, and the swinging is effectual only on condition that setting the swinging order and the

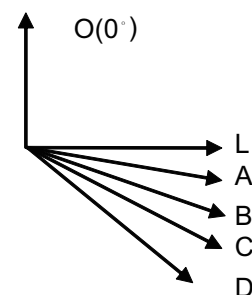

inner fan is running. The indoor fan and compressor may get the power when air deflector is on the default location.

(10) Display(NOTE:Nixie tube is not available for A8 panel.)

① Operation pattern and mode pattern display

All the display patterns will display for a time when the power on, the operation indication pattern will display in red under standby status. When the machine is start by remote control, the indication pattern will light and display the current operation mode (the mode light includes: Cooling, heating and dehumidify). If you close the light key, all the display patterns will close.

② Double-8 display

According to the different setting of remote control, the nixie light may display the current temperature (the temperature scope is from 16 to 30°C) and indoor ambient temperature. The heating and air supply temperature will display 25°C under auto-mode, the temperature will display 20°C under the heating mode, and under defrosting status, heating indicator on indoor unit OFF 0.5s and ON 10s.(If you set the fahrenheit temperature display, the nixie light will display according to fahrenheit temperature)

(11) Protection function and failure display

E2: Freeze-proofing protection E4: Exhausting protection E5: Overcurrent protection E6: Communication failure

F1: Indoor ambient sensor start and short circuit (continuously measured failure in 5S)

F2: Indoor evaporator sensor start and short circuit (continuously measured failure in 5S)

F3: Outdoor ambient sensor start and short circuit (continuously measured failure in 30S)

F4: Outdoor condenser sensor start and short circuit (continuously measured failure in 30S, and dont measure within 10 minutes after defrosted)

F5: Outdoor exhausting sensor start and short circuit (continuously measured failure in 30S after the compressor operated 3 minutes)

H3: Overload protection of compressor H5: Module protection PH: High-voltage protection PL: Low-voltage protection

P1: Nominal cooling and heating P2: Maximum cooling and heating P3: Medium cooling and heating

P0: Minimum cooling and heating

(12) Drying Function

You may start or stop the drying function under the modes of cooling and dehumidify at the starting status (The modes of automatism, heating and air supply do not have drying function). When you start the drying function, after stop the machine by pressing the switch button, you should keep running the inner fans for 2 minutes under low air damper (The swing will operate as the least status within 2 minutes, and other load is stopped), then stop the entire machine;When you stop the drying function, press the switch button will stop the machine directly.

When you start the drying function, operating the drying button will stop the inner fans and close the guide louver.

(13) Power-failure memory function

What will be memorized includes modes, up and down wind blow, light, preset temperature, preset wind speed, general timing (no memory for moment timing), and Fahrenheit /Celsius degree. When the unit is powered on again after power failure, operation continues according to memorized content. If timing is not set by the last remote control command, the system will memorize the last remote control command and operate in the mode specified in the last remote control command. If timing is set by the last remote control command and power failure happens before the preset time, the system, as powered on again, will memorize the timing function set by the last remote control command. Timing will be re-counted from the time at which the system is powered again. If timing is set by the last remote control command and timing of start or stop is reached before power failure, the system, as powered on again, will memorize operation state before power failure and will not perform timing action. Moment timing is out the range of memory.

(14) Refrigerant recycling function (applicable when changing installation location or in maintenance)

1. Enter refrigerant recycling function

Within 5min after energizing (unit ON or OFF status is ok), continuously press LIGHT button for 3 times within 3s to enter refrigerant recycling mode; Fo is displayed and refrigerant recycling function is started. At this moment, the maintenance people closes liquid valve. After 5min, stick the thimble of maintenance valve with a tool. If there is no refrigerant spraying out, close the gas valve immediately and then turn off the unit to remove the connection pipe.

2. Exit refrigerant recycling function

After entering refrigerant recycling mode, when receive any remote control signal or enter refrigerant recycling mode for 25min, the unit will exit refrigerant recycling mode automatically If the unit is in standby mode before refrigerant recycling, it will be still in standby mode after finishing refrigerant recycling; if the unit is in ON status before refrigerant recycling, it will still run in original operation mode.

(15) Compulsive Defrosting Function

1. Start up compulsory defrosting function

Under ON status, set heating mode with remote controller and adjust the temperature to 16°C. Press "+, -, +, -, +,-" button successively within 5s and the complete unit will enter into compulsory defrosting status. Meanwhile, heating indicator on indoor unit will ON 10s and OFF 0.5s successively. (Note: If complete unit has malfunction or stops operation due to protection, compulsory defrosting function can be started up after malfunction or protection is resumed.

2. Exit compulsory defrosting mode

After compulsory defrosting is started up, the complete unit will exit defrosting operation according to the actual defrosting result, and the complete unit will resume normal heating operation.

Part II : Installation and Maintenance

7. Notes for Installation and Maintenance

Safety Precautions: Important!

Please read the safety precautions carefully before installation and maintenance.

The following contents are very important for installation and maintenance.

Please follow the instructions below.

- The installation or maintenance must accord with the instructions.
- Comply with all national electrical codes and local electrical codes.
- Pay attention to the warnings and cautions in this manual.
- All installation and maintenance shall be performed by distributor or qualified person.
- All electric work must be performed by a licensed technician according to local regulations and the instructions given in this manual.
- Be caution during installation and maintenance. Prohibit incorrect operation to prevent electric shock, casualty and other accidents.



Warnings

Electrical Safety Precautions:

1. Cut off the power supply of air conditioner before checking and maintenance.
2. The air condition must apply specialized circuit and prohibit share the same circuit with other appliances.
3. The air conditioner should be installed in suitable location and ensure the power plug is touchable.
4. Make sure each wiring terminal is connected firmly during installation and maintenance.
5. Have the unit adequately grounded. The grounding wire can't be used for other purposes.
6. Must apply protective accessories such as protective boards, cable-cross loop and wire clip.
7. The live wire, neutral wire and grounding wire of power supply must be corresponding to the live wire, neutral wire and grounding wire of the air conditioner.
8. The power cord and power connection wires can't be pressed by hard objects.
9. If power cord or connection wire is broken, it must be replaced by a qualified person.

10. If the power cord or connection wire is not long enough, please get the specialized power cord or connection wire from the manufacture or distributor. Prohibit prolong the wire by yourself.

11. For the air conditioner without plug, an air switch must be installed in the circuit. The air switch should be all-pole parting and the contact parting distance should be more than 3mm.

12. Make sure all wires and pipes are connected properly and the valves are opened before energizing.

13. Check if there is electric leakage on the unit body. If yes, please eliminate the electric leakage.

14. Replace the fuse with a new one of the same specification if it is burnt down; don't replace it with a cooper wire or conducting wire.

15. If the unit is to be installed in a humid place, the circuit breaker must be installed.

Installation Safety Precautions:

1. Select the installation location according to the requirement of this manual.(See the requirements in installation part)
2. Handle unit transportation with care; the unit should not be carried by only one person if it is more than 20kg.
3. When installing the indoor unit and outdoor unit, a sufficient fixing bolt must be installed; make sure the installation support is firm.
4. Ware safety belt if the height of working is above 2m.
5. Use equipped components or appointed components during installation.
6. Make sure no foreign objects are left in the unit after finishing installation.

Refrigerant Safety Precautions:

1. Avoid contact between refrigerant and fire as it generates poisonous gas; Prohibit prolong the connection pipe by welding.
2. Apply specified refrigerant only. Never have it mixed with any other refrigerant. Never have air remain in the refrigerant line as it may lead to rupture or other hazards.
3. Make sure no refrigerant gas is leaking out when installation is completed.
4. If there is refrigerant leakage, please take sufficient measure to minimize the density of refrigerant.
5. Never touch the refrigerant piping or compressor without wearing glove to avoid scald or frostbite.

Improper installation may lead to fire hazard, explosion, electric shock or injury.

Main Tools for Installation and Maintenance

<p>1. Level meter, measuring tape</p> 	<p>2. Screw driver</p> 	<p>3. Impact drill, drill head, electric drill</p> 
<p>4. Electroprobe</p> 	<p>5. Universal meter</p> 	<p>6. Torque wrench, open-end wrench, inner hexagon spanner</p> 
<p>7. Electronic leakage detector</p> 	<p>8. Vacuum pump</p> 	<p>9. Pressure meter</p> 
<p>10. Pipe pliers, pipe cutter</p> 	<p>11. Pipe expander, pipe bender</p> 	<p>12. Soldering appliance, refrigerant container</p> 

8. Installation

8.1 Installation Dimension Diagram

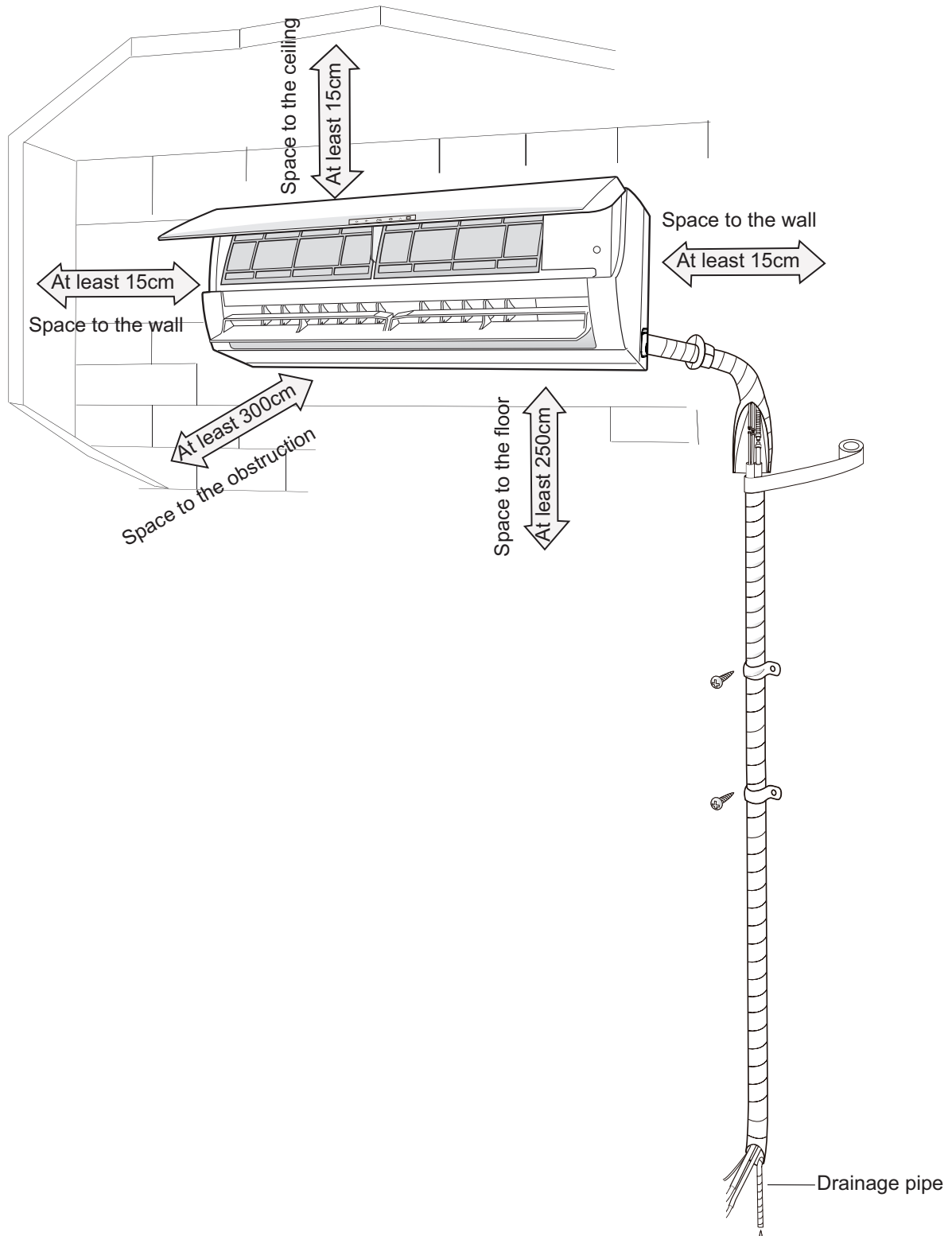

Installation procedures

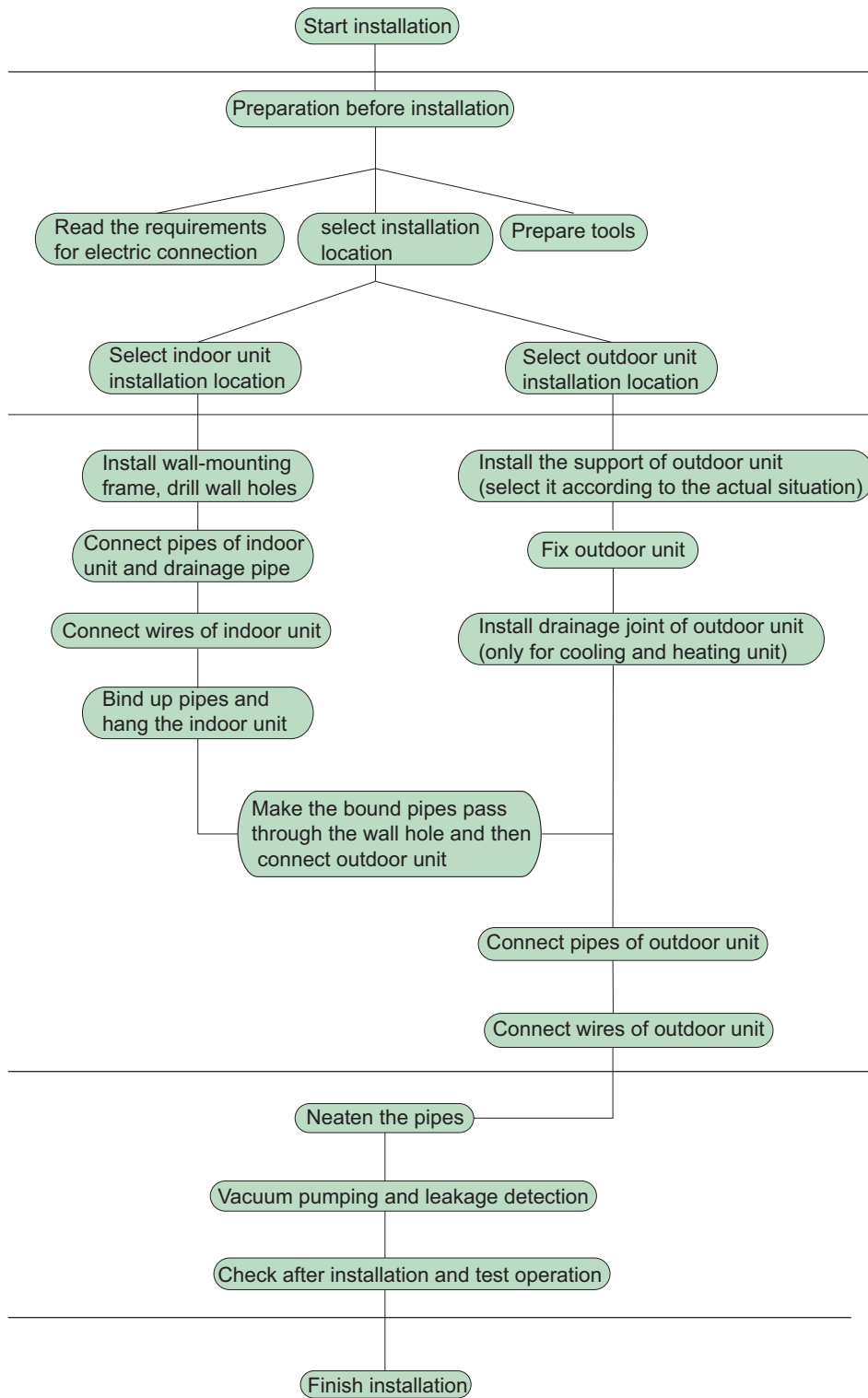

Note: this flow is only for reference; please find the more detailed installation steps in this section.

8.2 Installation Parts-checking

No.	Name	No.	Name
1	Indoor unit	8	Sealing gum
2	Outdoor unit	9	Wrapping tape
3	Connection pipe	10	Support of outdoor unit
4	Drainage pipe	11	Fixing screw
5	Wall-mounting frame	12	Drainage plug(cooling and heating unit)
6	Connecting cable(power cord)	13	Owner's manual, remote controller
7	Wall pipe		

⚠ Note:

1. Please contact the local agent for installation.
2. Don't use unqualified power cord.

8.3 Selection of Installation Location

1. Basic Requirement:

Installing the unit in the following places may cause malfunction. If it is unavoidable, please consult the local dealer:

- (1) The place with strong heat sources, vapors, flammable or explosive gas, or volatile objects spread in the air.
- (2) The place with high-frequency devices (such as welding machine, medical equipment).
- (3) The place near coast area.
- (4) The place with oil or fumes in the air.
- (5) The place with sulfured gas.
- (6) Other places with special circumstances.

2. Indoor Unit:

- (1) There should be no obstruction near air inlet and air outlet.
- (2) Select a location where the condensation water can be dispersed easily and won't affect other people.
- (3) Select a location which is convenient to connect the outdoor unit and near the power socket.
- (4) Select a location which is out of reach for children.
- (5) The location should be able to withstand the weight of indoor unit and won't increase noise and vibration.
- (6) The appliance must be installed 2.5m above floor.
- (7) Don't install the indoor unit right above the electric appliance.
- (8) The appliance shall not be installed in the laundry.

8.4 Electric Connection Requirement

1. Safety Precaution

- (1) Must follow the electric safety regulations when installing the unit.
- (2) According to the local safety regulations, use qualified power supply circuit and air switch.
- (3) Make sure the power supply matches with the requirement of air conditioner. Unstable power supply or incorrect wiring may result in electric shock, fire hazard or malfunction. Please install proper power supply cables before using the air conditioner.
- (4) Properly connect the live wire, neutral wire and grounding wire of power socket.
- (5) Be sure to cut off the power supply before proceeding any work related to electricity and safety.
- (6) Do not put through the power before finishing installation.
- (7) For appliances with type Y attachment, the instructions shall contain the substance of the following. If the supply cord is damaged, it must be replaced by the manufacturer, its service agent or similarly qualified persons in order to avoid a hazard.
- (8) The temperature of refrigerant circuit will be high, please keep the interconnection cable away from the copper tube.

2. Grounding Requirement:

- (1) The air conditioner is first class electric appliance. It must be properly grounded with specialized grounding device by a professional. Please make sure it is always grounded effectively, otherwise it may cause electric shock.
- (2) The yellow-green wire in air conditioner is grounding wire, which can't be used for other purposes.
- (3) The grounding resistance should comply with national electric safety regulations.
- (4) The appliance must be positioned so that the plug is accessible.
- (5) An all-pole disconnection switch having a contact separation of at least 3mm in all poles should be connected in fixed wiring.
- (6) Including an air switch with suitable capacity, please note the following table. Air switch should be included magnet buckle and heating buckle function, it can protect the circuit-short and overload. (Caution: please do not use the fuse only for protect the circuit)

8.5 Installation of Indoor Unit

1. Choosing Installation location

Recommend the installation location to the client and then confirm it with the client.

2. Install Wall-mounting Frame

- (1) Hang the wall-mounting frame on the wall; adjust it in horizontal position with the level meter and then point out the screw fixing holes on the wall.
- (2) Drill the screw fixing holes on the wall with impact drill (the specification of drill head should be the same as the plastic expansion particle) and then fill the plastic expansion particles in the holes.

(3) Fix the wall-mounting frame on the wall with tapping screws (ST4.2X25TA) and then check if the frame is firmly installed by pulling the frame. If the plastic expansion particle is loose, please drill another fixing hole nearby.

3. Install Wall-mounting Frame

(1) Choose the position of piping hole according to the direction of outlet pipe. The position of piping hole should be a little lower than the wall-mounted frame.(As show in Fig.1)

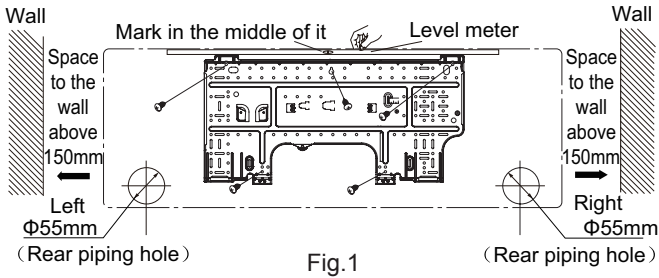

(2) Open a piping hole with the diameter of Φ55mm on the selected outlet pipe position. In order to drain smoothly, slant the piping hole on the wall slightly downward to the outdoor side with the gradient of 5-10°. (As show in Fig.2)

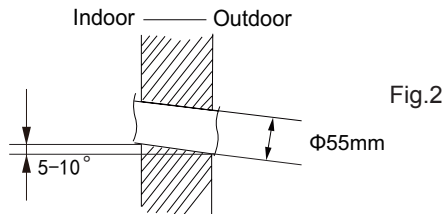

⚠ Note:

- (1) Pay attention to dust prevention and take relevant safety measures when opening the hole.
- (2) The plastic expansion particles are not provided and should be bought locally.

4. Outlet Pipe

(1) The pipe can be led out in the direction of right, rear right, left or rear left.(As show in Fig.3)

(2) When selecting leading out the pipe from left or right, please cut off the corresponding hole on the bottom case.(As show in Fig.4)

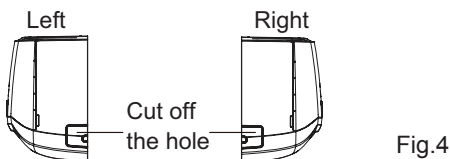
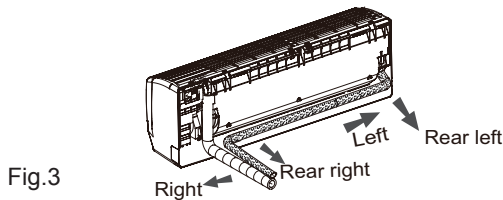

5. Connect the Pipe of Indoor Unit

- (1) Aim the pipe joint at the corresponding bellmouth.(As show in Fig.5)
- (2) Pretightening the union nut with hand.
- (3) Adjust the torque force by referring to the following sheet. Place the open-end wrench on the pipe joint and place the torque wrench on the union nut. Tighten the union nut with torque wrench.(As show in Fig.6)
- (4) Wrap the indoor pipe and joint of connection pipe with insulating pipe, and then wrap it with tape.(As show in Fig.7)

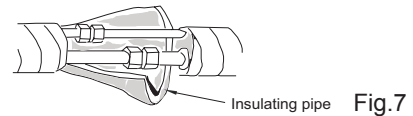
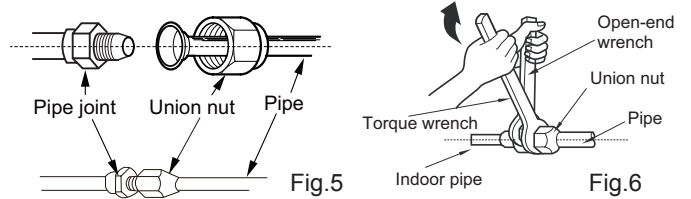

Refer to the following table for wrench moment of force:

Hex nut diameter(mm)	Tightening torque(N·m)
Φ6	15~20
Φ9.52	30~40
Φ12	45~55
Φ16	60~65
Φ19	70~75

6. Install Drain Hose

- (1) Connect the drain hose to the outlet pipe of indoor unit.(As show in Fig.8)
- (2) Bind the joint with tape.(As show in Fig.9)

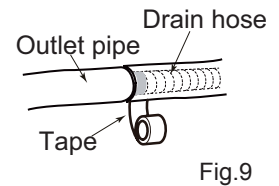
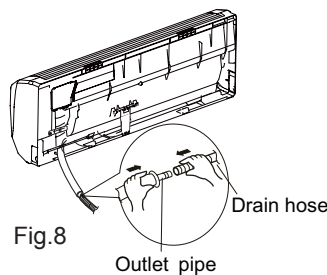

⚠ Note:

- (1) Add insulating pipe in the indoor drain hose in order to prevent condensation.
- (2) The plastic expansion particles are not provided. (As show in Fig.10)

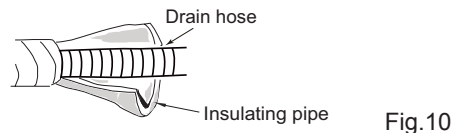

7. Connect Wire of Indoor Unit

(1) Open the panel, remove the screw on the wiring cover and then take down the cover.(As show in Fig.11)

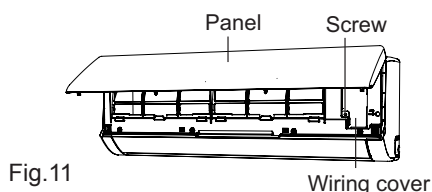

(2) Make the power connection wire go through the cable-cross hole at the back of indoor unit and then pull it out from the front side.(As show in Fig.12)

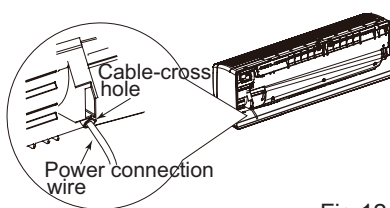

(3) Remove the wire clip; connect the power connection wire to the wiring terminal according to the color; tighten the screw and then fix the power connection wire with wire clip.(As show in Fig.13)

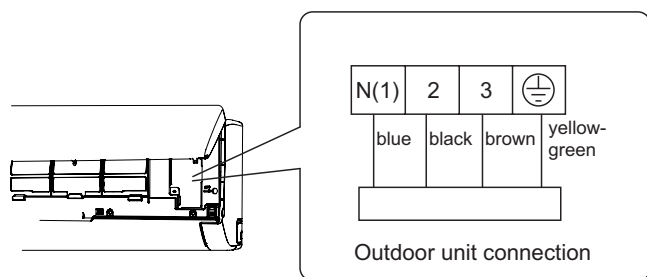

Fig.13

(4) Put wiring cover back and then tighten the screw.
 (5) Close the panel.

⚠ Note:

- (1) All wires of indoor unit and outdoor unit should be connected by a professional.
- (2) If the length of power connection wire is insufficient, please contact the supplier for a new one. Avoid extending the wire by yourself.
- (3) For the air conditioner with plug, the plug should be reachable after finishing installation.
- (4) For the air conditioner without plug, an air switch must be installed in the line. The air switch should be all-pole parting and the contact parting distance should be more than 3mm.

8. Bind up Pipe

- (1) Bind up the connection pipe, power cord and drain hose with the band.(As show in Fig.14)
- (2) Reserve a certain length of drain hose and power cord for installation when binding to a certain degree, separate the indoor power and then separate the drain hose.(As show in Fig.15)
- (3) Bind them evenly.
- (4) The liquid pipe and gas pipe should be bound separately at the end.

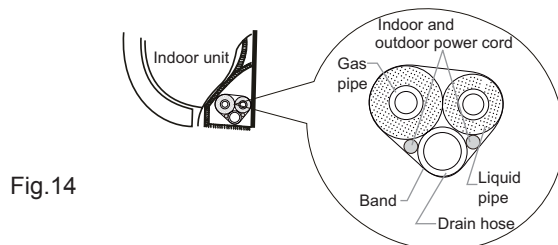

Fig.14

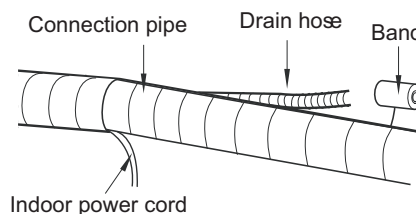

Fig.15

⚠ Note:

- (1) The power cord and control wire can't be crossed or winding.
- (2) The drain hose should be bound at the bottom.

9. Hang the Indoor Unit

- (1) Put the bound pipes in the wall pipe and then make them pass through the wall hole.
- (2) Hang the indoor unit on the wall-mounting frame.
- (3) Stuff the gap between pipes and wall hole with sealing gum.
- (4) Fix the wall pipe.(As show in Fig.16)
- (5) Check if the indoor unit is installed firmly and closed to the wall.(As show in Fig.17)

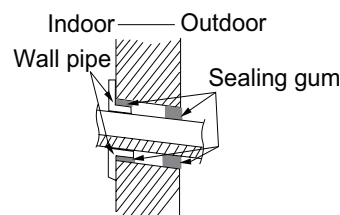

Fig.16

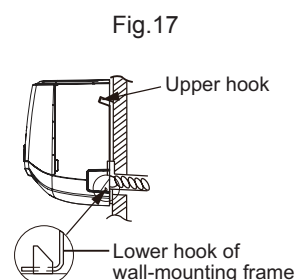

Fig.17

⚠ Note:

Do not bend the drain hose too excessively in order to prevent blocking.

8.6 Check after Installation and Test Operation

1. Check after Installation

Check according to the following requirement after finishing installation.

No.	Items to be checked	Possible malfunction
1	Has the unit been installed firmly?	The unit may drop, shake or emit noise.
2	Have you done the refrigerant leakage test?	It may cause insufficient cooling (heating) capacity.
3	Is heat insulation of pipeline sufficient?	It may cause condensation and water dripping.
4	Is water drained well?	It may cause condensation and water dripping.
5	Is the voltage of power supply according to the voltage marked on the nameplate?	It may cause malfunction or damage the parts.
6	Is electric wiring and pipeline installed correctly?	It may cause malfunction or damage the parts.
7	Is the unit grounded securely?	It may cause electric leakage.
8	Does the power cord follow the specification?	It may cause malfunction or damage the parts.
9	Is there any obstruction in air inlet and air outlet?	It may cause insufficient cooling (heating).
10	The dust and sundries caused during installation are removed?	It may cause malfunction or damaging the parts.
11	The gas valve and liquid valve of connection pipe are open completely?	It may cause insufficient cooling (heating) capacity.

2. Test Operation

(1) Preparation of test operation

- The client approves the air conditioner installation.
- Specify the important notes for air conditioner to the client.

(2) Method of test operation

- Put through the power, press ON/OFF button on the remote controller to start operation.
- Press MODE button to select AUTO, COOL, DRY, FAN and HEAT to check whether the operation is normal or not.
- If the ambient temperature is lower than 16°C, the air conditioner can't start cooling.

9. Maintenance

9.1 Flashing LED of Indoor/Outdoor Unit and Primary Judgement

No.	Malfunction Name	Display Method of Indoor Unit			Display Method of Outdoor Unit			A/C status	Possible Causes	
		Dual-8 Code Display	Indicator Display (during blinking, ON 0.5s and OFF 0.5s)			Indicator has 3 kinds of display status and during blinking, ON 0.5s and OFF 0.5s				
			Operation Indicator	Cool Indicator	Heating Indicator	Yellow Indicator	Red Indicator			Green Indicator
1	High pressure protection of system	E1							During cooling and drying operation, except indoor fan operates, all loads stop operation. During heating operation, the complete unit stops.	Possible reasons: 1. Refrigerant was superabundant; 2. Poor heat exchange (including filth blockage of heat exchanger and bad radiating environment); Ambient temperature is too high.
2	Antifreezing protection	E2				OFF 3S and blink 3 times			During cooling and drying operation, compressor and outdoor fan stop while indoor fan operates.	1. Poor air-return in indoor unit; 2. Fan speed is abnormal; 3. Evaporator is dirty.
3	System block or refrigerant leakage	E3					OFF 3S and blink 9 times		The Dual-8 Code Display will show E3 until the low pressure switch stop operation.	1.Low-pressure protection 2.Low-pressure protection of system 3.Low-pressure protection of compressor
4	High discharge temperature protection of compressor	E4				OFF 3S and blink 7 times			During cooling and drying operation, compressor and outdoor fan stop while indoor fan operates. During heating operation, all loads stop.	Please refer to the malfunction analysis (discharge protection, overload).
5	Overcurrent protection	E5				OFF 3S and blink 5 times			During cooling and drying operation, compressor and outdoor fan stop while indoor fan operates. During heating operation, all loads stop.	1. Supply voltage is unstable; 2. Supply voltage is too low and load is too high; 3. Evaporator is dirty.
6	Communication Malfunction	E6						OFF	During cooling operation, compressor stops while indoor fan motor operates. During heating operation, the complete unit stops.	Refer to the corresponding malfunction analysis.
7	High temperature resistant protection	E8				OFF 3S and blink 6 times			During cooling operation: compressor will stop while indoor fan will operate. During heating operation, the complete unit stops.	Refer to the malfunction analysis (overload, high temperature resistant).
8	EEPROM malfunction	EE				OFF 3S and blink 11 times			During cooling and drying operation, compressor will stop while indoor fan will operate; During heating operation, the complete unit will stop	Replace outdoor control panel AP1
9	Limit/ decrease frequency due to high temperature of module	EU							All loads operate normally, while operation frequency for compressor is decreased	Discharging after the complete unit is de-energized for 20mins, check whether the thermal grease on IPM Module of outdoor control panel AP1 is sufficient and whether the radiator is inserted tightly. If its no use, please replace control panel AP1.
10	Malfunction protection of jumper cap	C5							Wireless remote receiver and button are effective, but can not dispose the related command	1. No jumper cap insert on mainboard. 2. Incorrect insert of jumper cap. 3. Jumper cap damaged. 4. Abnormal detecting circuit of mainboard.

No.	Malfunction Name	Display Method of Indoor Unit			Display Method of Outdoor Unit			A/C status	Possible Causes	
		Dual-8 Code Display	Indicator Display (during blinking, ON 0.5s and OFF 0.5s)			Indicator has 3 kinds of display status and during blinking, ON 0.5s and OFF 0.5s				
			Operation Indicator	Cool Indicator	Heating Indicator	Yellow Indicator	Red Indicator			Green Indicator
11	Gathering refrigerant	Fo							When the outdoor unit receive signal of Gathering refrigerant ,the system will be forced to run under cooling mode for gathering refrigerant	Nominal cooling mode
12	Indoor ambient temperature sensor is open/short circuited	F1							During cooling and drying operation, indoor unit operates while other loads will stop; during heating operation, the complete unit will stop operation.	<ol style="list-style-type: none"> Loosening or bad contact of indoor ambient temp. sensor and mainboard terminal. Components in mainboard fell down leads short circuit. Indoor ambient temp. sensor damaged.(check with sensor resistance value chart) Mainboard damaged.
13	Indoor evaporator temperature sensor is open/short circuited	F2							AC stops operation once reaches the setting temperature. Cooling, drying: internal fan motor stops operation while other loads stop operation; heating: AC stop operation	<ol style="list-style-type: none"> Loosening or bad contact of Indoor evaporator temp. sensor and mainboard terminal. Components on the mainboard fall down leads short circuit. Indoor evaporator temp. sensor damaged.(check temp. sensor value chart for testing) Mainboard damaged.
14	Outdoor ambient temperature sensor is open/short circuited	F3					OFF 3S and blink 6 times		During cooling and drying operating, compressor stops while indoor fan operates; During heating operation, the complete unit will stop operation	Outdoor temperature sensor hasnt been connected well or is damaged. Please check it by referring to the resistance table for temperature sensor)
15	Outdoor condenser temperature sensor is open/short circuited	F4					OFF 3S and blink 5 times		During cooling and drying operation, compressor stops while indoor fan will operate; During heating operation, the complete unit will stop operation.	Outdoor temperature sensor hasnt been connected well or is damaged. Please check it by referring to the resistance table for temperature sensor)
16	Outdoor discharge temperature sensor is open/short circuited	F5					OFF 3S and blink 7 times		During cooling and drying operation, compressor will sop after operating for about 3 mins, while indoor fan will operate; During heating operation, the complete unit will stop after operating for about 3 mins.	<ol style="list-style-type: none"> Outdoor temperature sensor hasnt been connected well or is damaged. Please check it by referring to the resistance table for temperature sensor) The head of temperature sensor hasnt been inserted into the copper tube
17	Limit/ decrease frequency due to overload	F6					OFF 3S and blink 3 times		All loads operate normally, while operation frequency for compressor is decreased	Refer to the malfunction analysis (overload, high temperature resistant)
18	Decrease frequency due to overcurrent	F8					OFF 3S and blink once		All loads operate normally, while operation frequency for compressor is decreased	The input supply voltage is too low; System pressure is too high and overload



No.	Malfunction Name	Display Method of Indoor Unit			Display Method of Outdoor Unit			A/C status	Possible Causes	
		Dual-8 Code Display	Indicator Display (during blinking, ON 0.5s and OFF 0.5s)			Indicator has 3 kinds of display status and during blinking, ON 0.5s and OFF 0.5s				
			Operation Indicator	Cool Indicator	Heating Indicator	Yellow Indicator	Red Indicator			Green Indicator
19	Decrease frequency due to high air discharge	F9					OFF 3S and blink twice	All loads operate normally, while operation frequency for compressor is decreased	Overload or temperature is too high; Refrigerant is insufficient; Malfunction of electric expansion valve (EKV)	
20	Limit/decrease frequency due to antifreezing	FH					OFF 3S and blink 4 times	All loads operate normally, while operation frequency for compressor is decreased	Poor air-return in indoor unit or fan speed is too low	
21	Voltage for DC bus-bar is too high	PH					OFF 3S and blink 13 times	During cooling and drying operation, compressor will stop while indoor fan will operate; During heating operation, the complete unit will stop operation.	1. Measure the voltage of position L and N on wiring board (XT), if the voltage is higher than 265VAC, turn on the unit after the supply voltage is increased to the normal range. 2.If the AC input is normal, measure the voltage of electrolytic capacitor C on control panel (AP1), if its normal, theres malfunction for the circuit, please replace the control panel (AP1)	
22	Voltage of DC bus-bar is too low	PL					OFF 3S and blink 12 times	During cooling and drying operation, compressor will stop while indoor fan will operate; During heating operation, the complete unit will stop	1. Measure the voltage of position L and N on wiring board (XT), if the voltage is higher than 150VAC, turn on the unit after the supply voltage is increased to the normal range. 2.If the AC input is normal, measure the voltage of electrolytic capacitor C on control panel (AP1), if its normal, theres malfunction for the circuit, please replace the control panel (AP1)	
23	Compressor Min frequency in test state	P0							Showing during min. cooling or min. heating test	
24	Compressor rated frequency in test state	P1							Showing during nominal cooling or nominal heating test	
25	Compressor maximum frequency in test state	P2							Showing during max. cooling or max. heating test	

No.	Malfunction Name	Display Method of Indoor Unit			Display Method of Outdoor Unit			A/C status	Possible Causes	
		Dual-8 Code Display	Indicator Display (during blinking, ON 0.5s and OFF 0.5s)			Indicator has 3 kinds of display status and during blinking, ON 0.5s and OFF 0.5s				
			Operation Indicator	Cool Indicator	Heating Indicator	Yellow Indicator	Red Indicator			Green Indicator
26	Compressor intermediate frequency in test state	P3							Showing during middle cooling or middle heating test	
27	Overcurrent protection of phase current for compressor	P5						During cooling and drying operation, compressor will stop while indoor fan will operate; During heating operation, the complete unit will stop operation.	Refer to the malfunction analysis (IPM protection, loss of synchronism protection and overcurrent protection of phase current for compressor).	
28	Charging malfunction of capacitor	PU						During cooling and drying operation, compressor will stop while indoor fan will operate; During heating operation, the complete unit will stop	Refer to the part three—charging malfunction analysis of capacitor	
29	Malfunction of module temperature sensor circuit	P7						During cooling and drying operation, compressor will stop while indoor fan will operate; During heating operation, the complete unit will stop	Replace outdoor control panel AP1	
30	Module high temperature protection	P8						During cooling operation, compressor will stop while indoor fan will operate; During heating operation, the complete unit will stop	After the complete unit is de-energized for 20mins, check whether the thermal grease on IPM Module of outdoor control panel AP1 is sufficient and whether the radiator is inserted tightly. If its no use, please replace control panel AP1.	
31	Overload protection for compressor	H3				OFF 3S and blink 8 times		During cooling and drying operation, compressor will stop while indoor fan will operate; During heating operation, the complete unit will stop operation.	1. Wiring terminal OVC-COMP is loosened. In normal state, the resistance for this terminal should be less than 1ohm. 2.Refer to the malfunction analysis (discharge protection, overload)	
32	IPM protection	H5				OFF 3S and blink 4 times		During cooling and drying operation, compressor will stop while indoor fan will operate; During heating operation, the complete unit will stop operation.	Refer to the malfunction analysis (IPM protection, loss of synchronism protection and overcurrent protection of phase current for compressor).	
33	Module temperature is too high	H5				OFF 3S and blink 10 times				

No.	Malfunction Name	Display Method of Indoor Unit			Display Method of Outdoor Unit			A/C status	Possible Causes	
		Dual-8 Code Display	Indicator Display (during blinking, ON 0.5s and OFF 0.5s)			Indicator has 3 kinds of display status and during blinking, ON 0.5s and OFF 0.5s				
			Operation Indicator	Cool Indicator	Heating Indicator	Yellow Indicator	Red Indicator	Green Indicator		
34	Internal motor (fan motor) do not operate	H6							Internal fan motor, external fan motor, compressor and electric heater stop operation, guide louver stops at present location.	1. Bad contact of DC motor feedback terminal. 2. Bad contact of DC motor control end. 3. Fan motor is stalling. 4. Motor malfunction. 5. Malfunction of mainboard rev detecting circuit.
35	Desynchronizing of compressor	H7							During cooling and drying operation, compressor will stop while indoor fan will operate; During heating operation, the complete unit will stop operation.	Refer to the malfunction analysis (IPM protection, loss of synchronism protection and overcurrent protection of phase current for compressor.
36	PFC protection	HC				OFF 3S and blink 14 times			During cooling and drying operation, compressor will stop while indoor fan will operate; During heating operation, the complete unit will stop operation.	Refer to the malfunction analysis
37	Outdoor DC fan motor malfunction	L3					OFF 3S and blink 14 times		Outdoor DC fan motor malfunction lead to compressor stop operation,	DC fan motor malfunction or system blocked or the connector loosed
38	power protection	L9				OFF 3S and blink 9 times			compressor stop operation and Outdoor fan motor will stop 30s latter , 3 minutes latter fan motor and compressor will restart	To protect the electrical components when detect high power
39	Indoor unit and outdoor unit doesnt match	LP				OFF 3S and blink 16 times			compressor and Outdoor fan motor cant work	Indoor unit and outdoor unit doesnt match
40	Failure start-up	LC							During cooling and drying operation, compressor will stop while indoor fan will operate; During heating operation, the complete unit will stop operation.	Refer to the malfunction analysis
41	Normal communication							continuously		
42	Defrosting				OFF 3S and blink once (during blinking, ON 10s and OFF 0.5s)	OFF 3S and blink twice			Defrosting will occur in heating mode. Compressor will operate while indoor fan will stop operation.	Its the normal state

NO.	Malfunction Name	Display Method of Indoor Unit			Display Method of Outdoor Unit			A/C status	Possible Causes	
		Dual-8 Code Display	Indicator Display (during blinking, ON 0.5s and OFF 0.5s)			Indicator has 3 kinds of display status and during blinking, ON 0.5s and OFF 0.5s				
			Operation Indicator	Cool Indicator	Heating Indicator	Yellow Indicator	Red Indicator			Green Indicator
43	Malfunction of phase current detection circuit for compressor	U1							During cooling and drying operation, compressor will stop while indoor fan will operate; During heating operation, the complete unit will stop	Replace outdoor control panel AP1
44	Malfunction of voltage dropping for DC bus-bar	U3							During cooling and drying operation, compressor will stop while indoor fan will operate; During heating operation, the complete unit will stop	Supply voltage is unstable
45	Malfunction of complete units current detection	U5							During cooling and drying operation, the compressor will stop while indoor fan will operate; During heating operating, the complete unit will stop operation.	Theres circuit malfunction on outdoor units control panel AP1, please replace the outdoor units control panel AP1.
46	The four-way valve is abnormal	U7							If this malfunction occurs during heating operation, the complete unit will stop operation.	1.Supply voltage is lower than AC175V; 2.Wiring terminal 4V is loosened or broken; 3.4V is damaged, please replace 4V.
47	Frequency limiting (power)						OFF 3S and blink 13 times			
48	Compressor is open-circuited						OFF 3S and blink once			
49	The temperature for turning on the unit is reached						OFF 3S and blink 8 times			
50	Frequency limiting (module temperature)						OFF 3S and blink 11 times			
51	Malfunction of zero-cross detection circuit	U8							The complete unit stops	1.Power supply is abnormal; 2.Detection circuit of indoor control mainboard is abnormal.

If malfunction occurs, corresponding code will display and the unit will resume normal until protection or malfunction disappears.

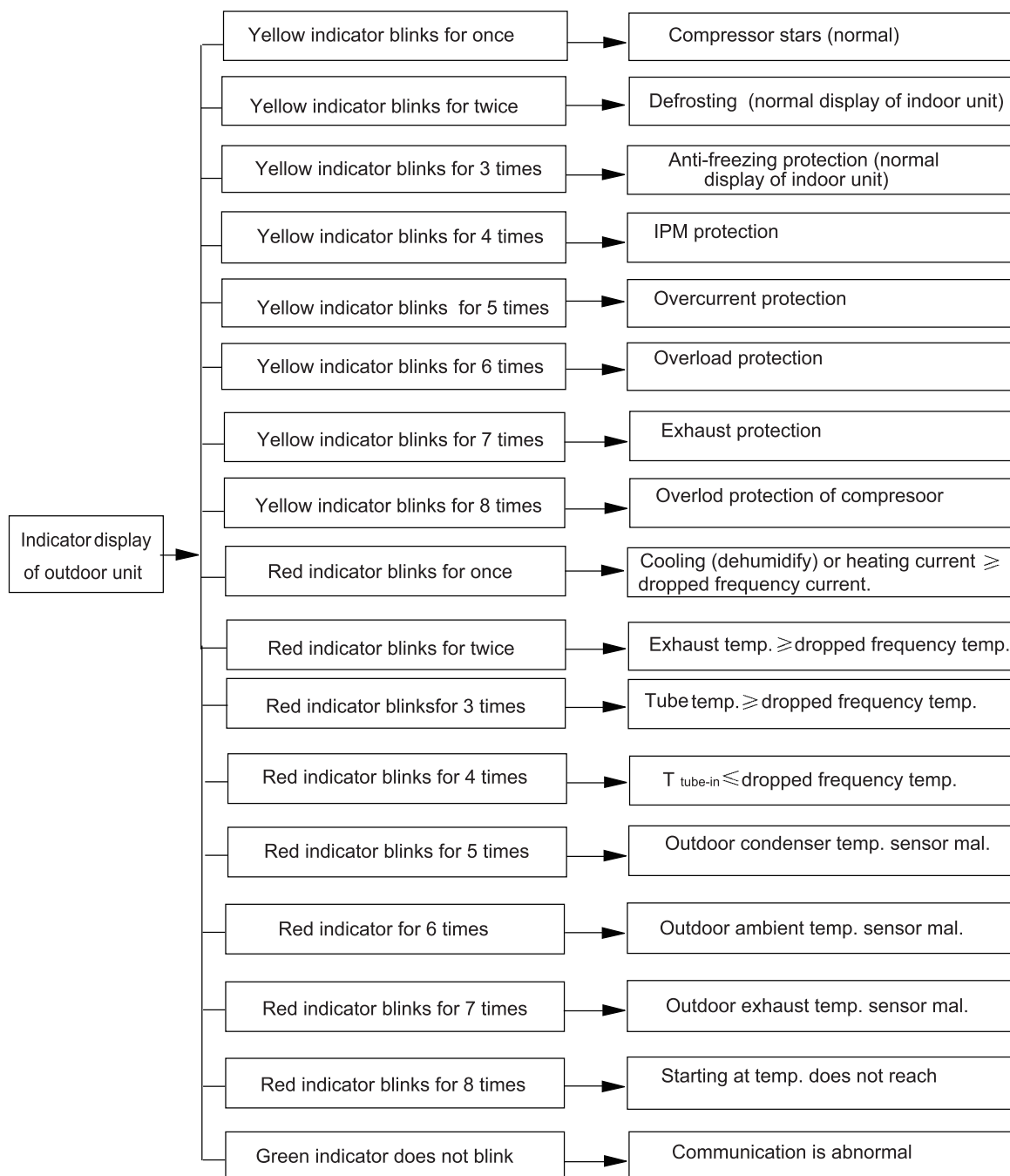

Analysis or processing of some of the malfunction display:

1. Compressor discharge protection

Possible causes: shortage of refrigerant; blockage of air filter; poor ventilation or air flow short pass for condenser; the system has noncondensing gas (such as air, water etc.); blockage of capillary assy (including filter); leakage inside four-way valve causes incorrect operation; malfunction of compressor; malfunction of protection relay; malfunction of discharge sensor; outdoor temperature too high.

Processing method: refer to the malfunction analysis in the above section.

2. Low voltage overcurrent protection

Possible cause: Sudden drop of supply voltage.

3. Communication malfunction

Processing method: Check if communication signal cable is connected reliably.

4. Sensor open or short circuit

Processing method: Check whether sensor is normal, connected with the corresponding position on the controller and if damage of lead wire is found.

5. Compressor over load protection

Possible causes: insufficient or too much refrigerant; blockage of capillary and increase of suction temp.; improper running of compressor, burning in or stuck of bearing, damage of discharge valve; malfunction of protector.

Processing method: adjust refrigerant amount; replace the capillary; replace the compressor; use universal meter to check if the contactor of compressor is fine when it is not over heated, if not replace the protector.

6. System malfunction

i.e. overload protection. When tube temperature (Check the temperature of outdoor heat exchanger when cooling and check the temperature of indoor heat exchanger when heating) is too high, protection will be activated.

Possible causes: Outdoor temperature is too high when cooling; insufficient outdoor air circulation; refrigerant flow malfunction. please refer to the malfunction analysis in the previous section for handling method .

7. IPM module protection

Processing method: Once the module malfunction happens, if it persists for a long time and can not be self-canceled, cut off the power and turn off the unit, and then re-energize the unit again after about 10 min. After repeating the procedure for several times, if the malfunction still exists, replace the module.

9.2 Procedure of Troubleshooting

(1) Malfunction of Temperature Sensor

Main detection points:

- Is the wiring terminal between the temperature sensor and the controller loosened or poorly contacted?
- Is there short circuit due to trip-over of the parts?
- Is the temperature sensor broken?
- Is mainboard broken?

Malfunction diagnosis process:

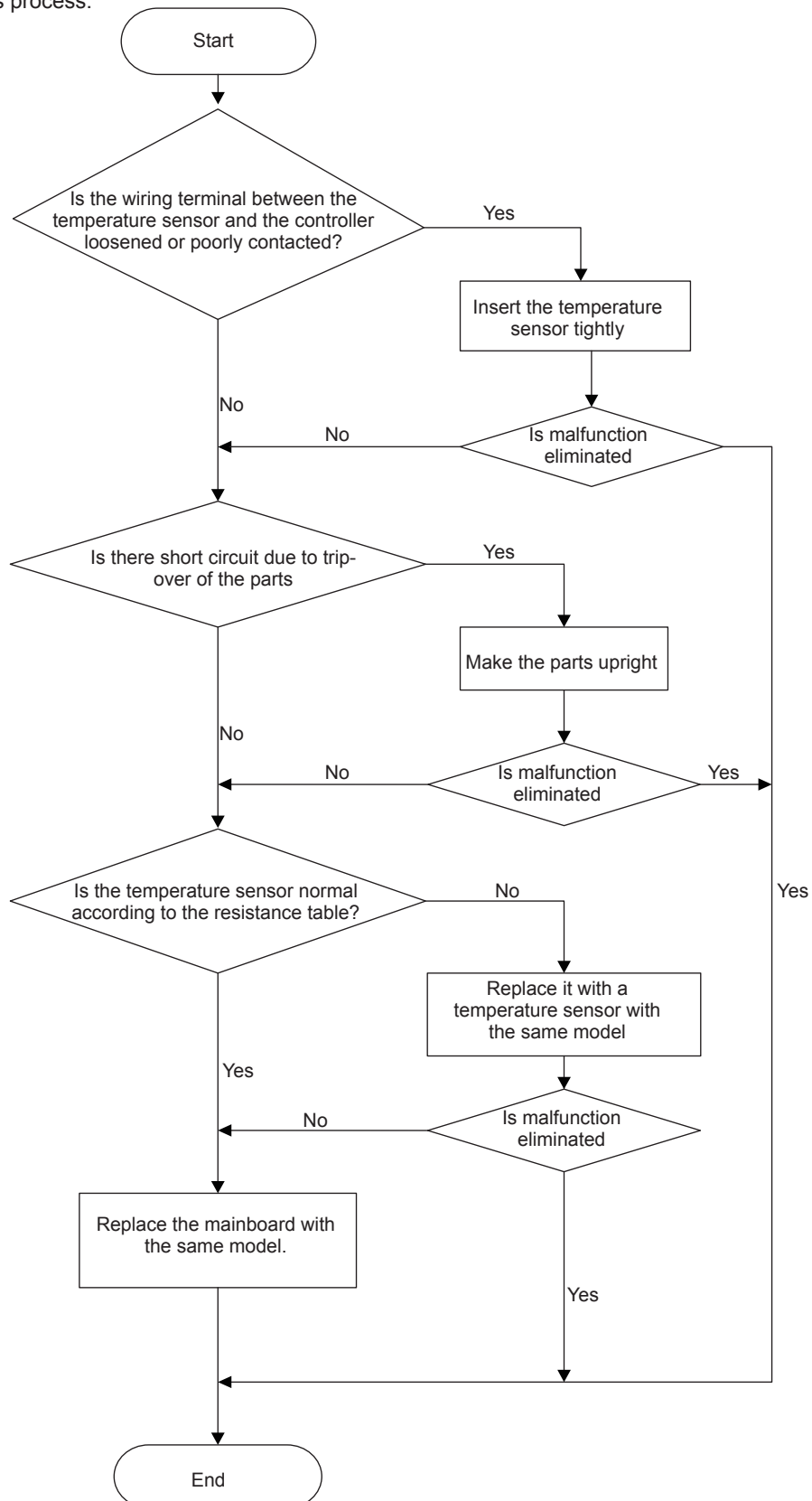

(2) Malfunction of Blocked Protection of IDU Fan Motor

Main detection points:

- SmoothlyIs the control terminal of PG motor connected tightly?
- SmoothlyIs the feedback interface of PG motor connected tightly?
- The fan motor can't operate?
- The motor is broken?
- Detectioncircuit of the mainboard is defined abnormal?

Malfunction diagnosis process:

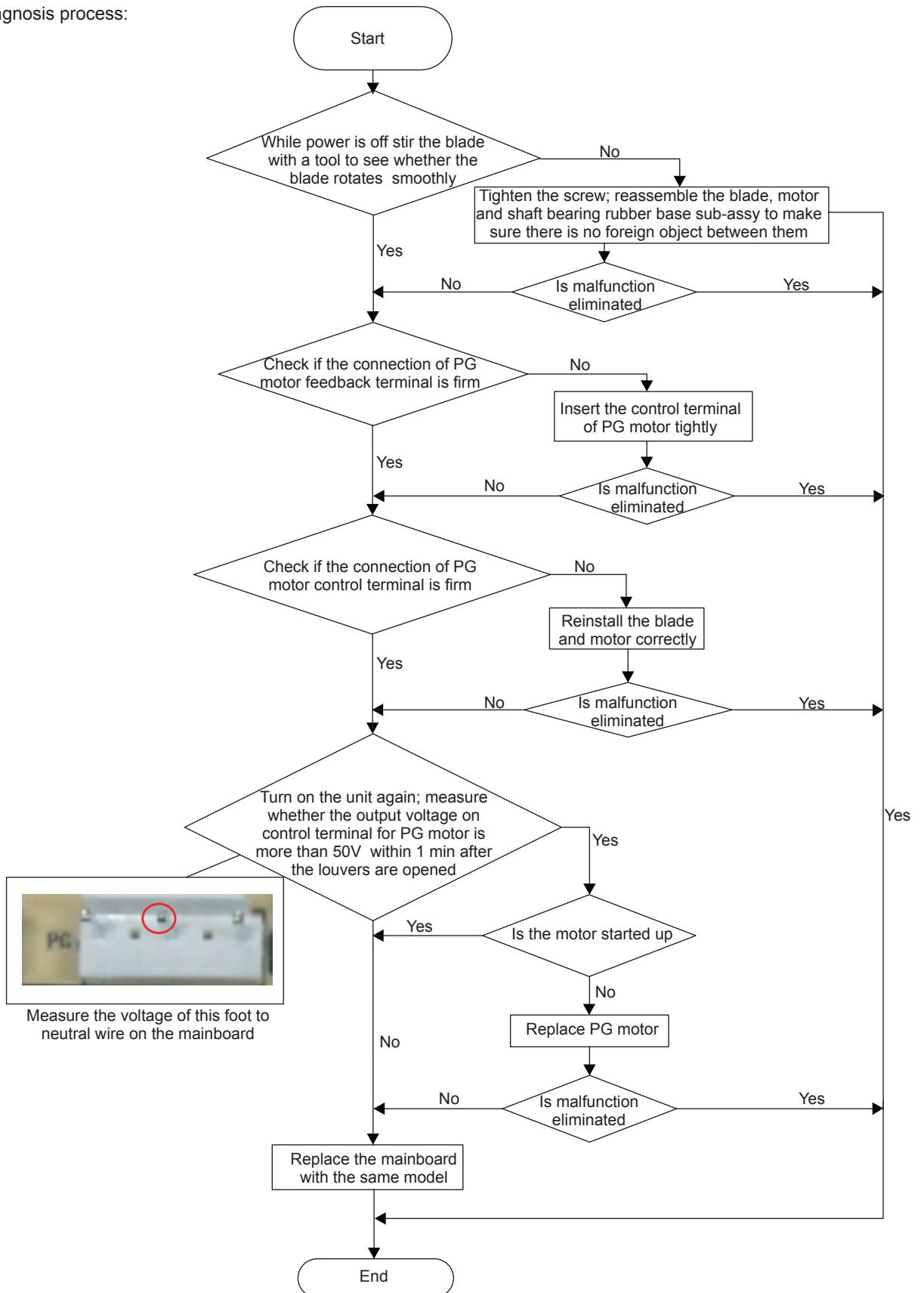

(3) Malfunction of Protection of Jumper Cap

Main detection points:

- Is there jumper cap on the mainboard?
- Is the jumper cap inserted correctly and tightly?
- The jumper is broken?
- The motor is broken?
- Detection circuit of the mainboard is defined abnormal?

Malfunction diagnosis process:

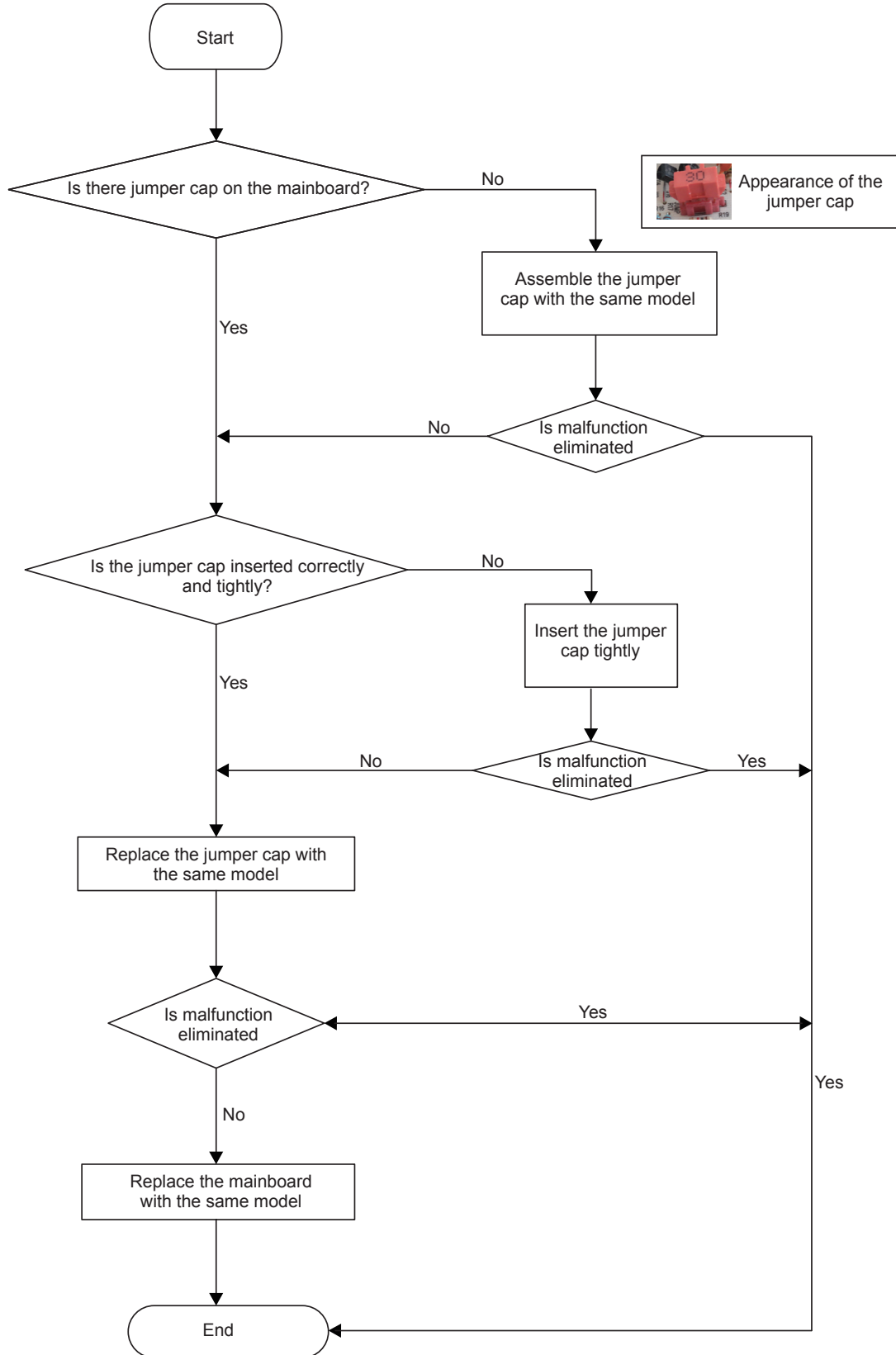

(4) Malfunction of Zero-crossing Inspection Circuit Malfunction of the IDU Fan Motor

Main detection points:

- Instant energization after de-energization while the capacitor discharges slowly?
- The zero-cross detection circuit of the mainboard is defined abnormal?

Malfunction diagnosis process:

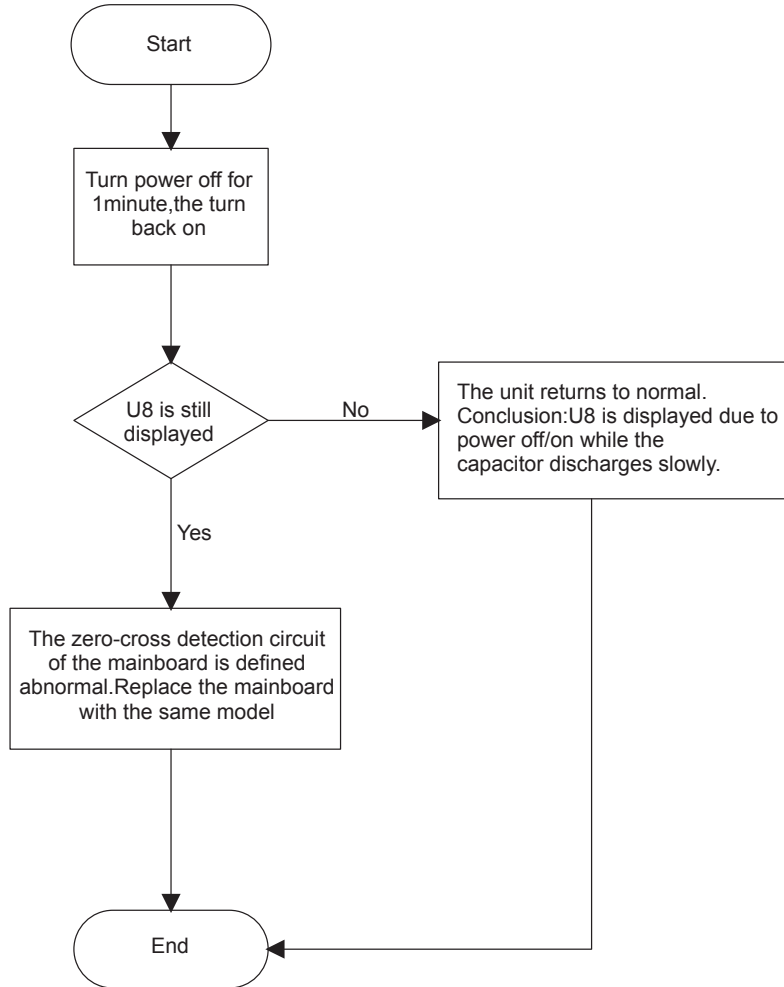

(5) Communication Malfunction

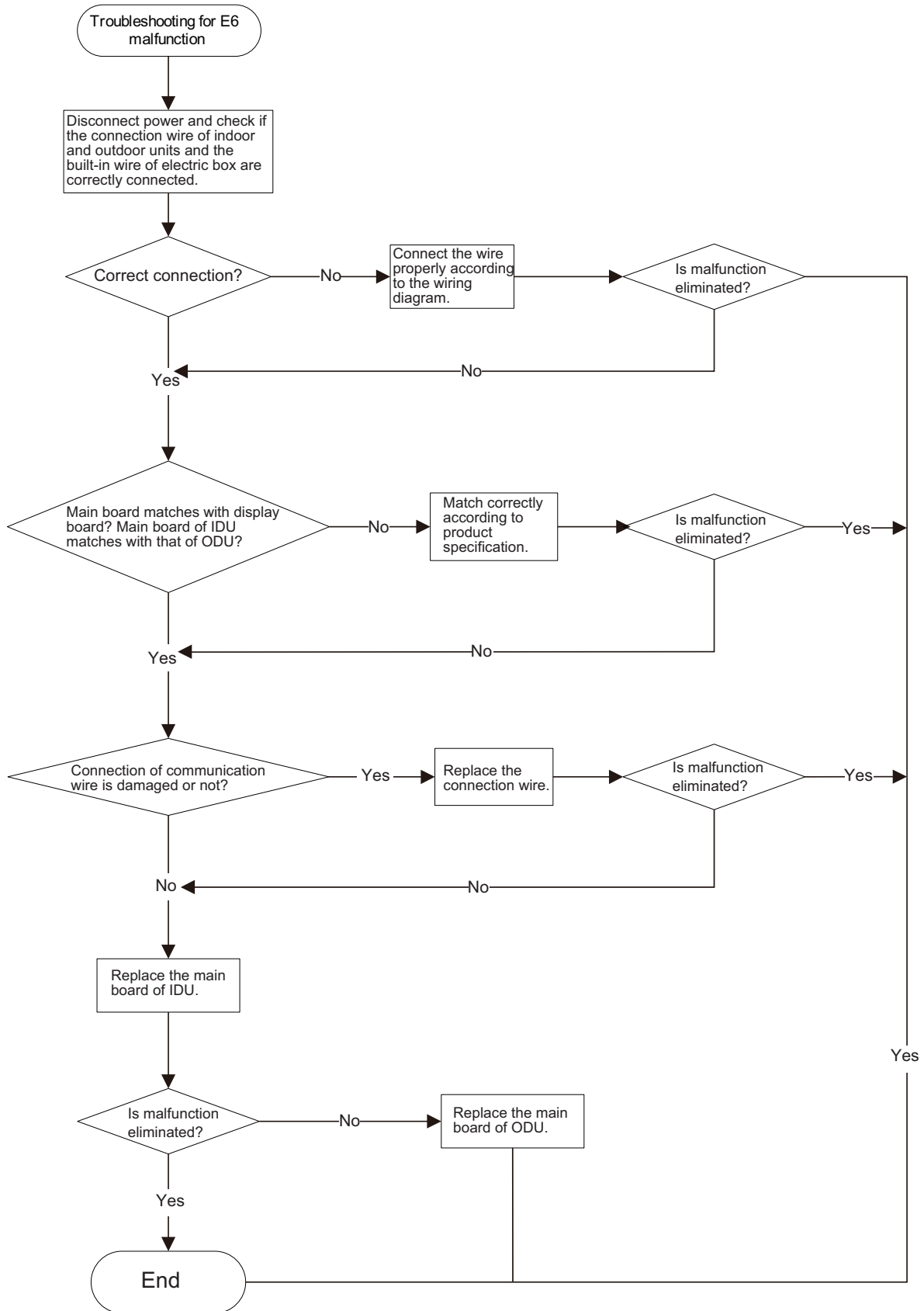

9.3 Maintenance Method for Normal Malfunction

1. Air Conditioner Can't be Started Up

Possible Causes	Discriminating Method (Air conditioner Status)	Troubleshooting
No power supply, or poor connection for power plug	After energization, operation indicator isn't bright and the buzzer can't give out sound	Confirm whether it's due to power failure. If yes, wait for power recovery. If not, check power supply circuit and make sure the power plug is connected well.
Wrong wire connection between indoor unit and outdoor unit, or poor connection for wiring terminals	Under normal power supply circumstances, operation indicator isn't bright after energization	Check the circuit according to circuit diagram and connect wires correctly. Make sure all wiring terminals are connected firmly
Electric leakage for air conditioner	After energization, room circuit breaker trips off at once	Make sure the air conditioner is grounded reliably Make sure wires of air conditioner is connected correctly Check the wiring inside air conditioner. Check whether the insulation layer of power cord is damaged; if yes, place the power cord.
Model selection for air switch is improper	After energization, air switch trips off	Select proper air switch
Malfunction of remote controller	After energization, operation indicator is bright, while no display on remote controller or buttons have no action.	Replace batteries for remote controller Repair or replace remote controller

2. Poor Cooling (Heating) for Air Conditioner

Possible Causes	Discriminating Method (Air conditioner Status)	Troubleshooting
Set temperature is improper	Observe the set temperature on remote controller	Adjust the set temperature
Rotation speed of the IDU fan motor is set too low	Small wind blow	Set the fan speed at high or medium
Filter of indoor unit is blocked	Check the filter to see it's blocked	Clean the filter
Installation position for indoor unit and outdoor unit is improper	Check whether the installation position is proper according to installation requirement for air conditioner	Adjust the installation position, and install the rainproof and sunproof for outdoor unit
Refrigerant is leaking	Discharged air temperature during cooling is higher than normal discharged wind temperature; Discharged air temperature during heating is lower than normal discharged wind temperature; Unit's pressure is much lower than regulated range	Find out the leakage causes and deal with it. Add refrigerant.
Malfunction of 4-way valve	Blow cold wind during heating	Replace the 4-way valve
Malfunction of capillary	Discharged air temperature during cooling is higher than normal discharged wind temperature; Discharged air temperature during heating is lower than normal discharged wind temperature; Unit's pressure is much lower than regulated range. If refrigerant isn't leaking, part of capillary is blocked	Replace the capillary
Flow volume of valve is insufficient	The pressure of valves is much lower than that stated in the specification	Open the valve completely
Malfunction of horizontal louver	Horizontal louver can't swing	Refer to point 3 of maintenance method for details
Malfunction of the IDU fan motor	The IDU fan motor can't operate	Refer to troubleshooting for H6 for maintenance method in details
Malfunction of the ODU fan motor	The ODU fan motor can't operate	Refer to point 4 of maintenance method for details
Malfunction of compressor	Compressor can't operate	Refer to point 5 of maintenance method for details

3. Horizontal Louver Can't Swing

Possible Causes	Discriminating Method (Air conditioner Status)	Troubleshooting
Wrong wire connection, or poor connection	Check the wiring status according to circuit diagram	Connect wires according to wiring diagram to make sure all wiring terminals are connected firmly
Stepping motor is damaged	Stepping motor can't operate	Repair or replace stepping motor
Main board is damaged	Others are all normal, while horizontal louver can't operate	Replace the main board with the same model

4. ODU Fan Motor Can't Operate

Possible causes	Discriminating method (air conditioner status)	Troubleshooting
Wrong wire connection, or poor connection	Check the wiring status according to circuit diagram	Connect wires according to wiring diagram to make sure all wiring terminals are connected firmly
Capacity of the ODU fan motor is damaged	Measure the capacity of fan capacitor with an universal meter and find that the capacity is out of the deviation range indicated on the nameplate of fan capacitor.	Replace the capacity of fan
Power voltage is a little low or high	Use universal meter to measure the power supply voltage. The voltage is a little high or low	Suggest to equip with voltage regulator
Motor of outdoor unit is damaged	When unit is on, cooling/heating performance is bad and ODU compressor generates a lot of noise and heat.	Change compressor oil and refrigerant. If no better, replace the compressor with a new one

5. Compressor Can't Operate

Possible causes	Discriminating method (air conditioner status)	Troubleshooting
Wrong wire connection, or poor connection	Check the wiring status according to circuit diagram	Connect wires according to wiring diagram to make sure all wiring terminals are connected firmly
Capacity of compressor is damaged	Measure the capacity of fan capacitor with an universal meter and find that the capacity is out of the deviation range indicated on the nameplate of fan capacitor.	Replace the compressor capacitor
Power voltage is a little low or high	Use universal meter to measure the power supply voltage. The voltage is a little high or low	Suggest to equip with voltage regulator
Coil of compressor is burnt out	Use universal meter to measure the resistance between compressor terminals and it's 0	Repair or replace compressor
Cylinder of compressor is blocked	Compressor can't operate	Repair or replace compressor

6. Air Conditioner is Leaking

Possible causes	Discriminating method (air conditioner status)	Troubleshooting
Drain pipe is blocked	Water leaking from indoor unit	Eliminate the foreign objects inside the drain pipe
Drain pipe is broken	Water leaking from drain pipe	Replace drain pipe
Wrapping is not tight	Water leaking from the pipe connection place of indoor unit	Wrap it again and bundle it tightly

7. Abnormal Sound and Vibration

Possible causes	Discriminating method (air conditioner status)	Troubleshooting
When turn on or turn off the unit, the panel and other parts will expand and there's abnormal sound	There's the sound of "PAPA"	Normal phenomenon. Abnormal sound will disappear after a few minutes.
When turn on or turn off the unit, there's abnormal sound due to flow of refrigerant inside air conditioner	Water-running sound can be heard	Normal phenomenon. Abnormal sound will disappear after a few minutes.
Foreign objects inside the indoor unit or there're parts touching together inside the indoor unit	There's abnormal sound fro indoor unit	Remove foreign objects. Adjust all parts' position of indoor unit, tighten screws and stick damping plaster between connected parts
Foreign objects inside the outdoor unit or there're parts touching together inside the outdoor unit	There's abnormal sound fro outdoor unit	Remove foreign objects. Adjust all parts' position of outdoor unit, tighten screws and stick damping plaster between connected parts
Short circuit inside the magnetic coil	During heating, the way valve has abnormal electromagnetic sound	Replace magnetic coil
Abnormal shake of compressor	Outdoor unit gives out abnormal sound	Adjust the support foot mat of compressor, tighten the bolts
Abnormal sound inside the compressor	Abnormal sound inside the compressor	If add too much refrigerant during maintenance, please reduce refrigerant properly. Replace compressor for other circumstances.

10. Exploded View and Parts List

Indoor Unit

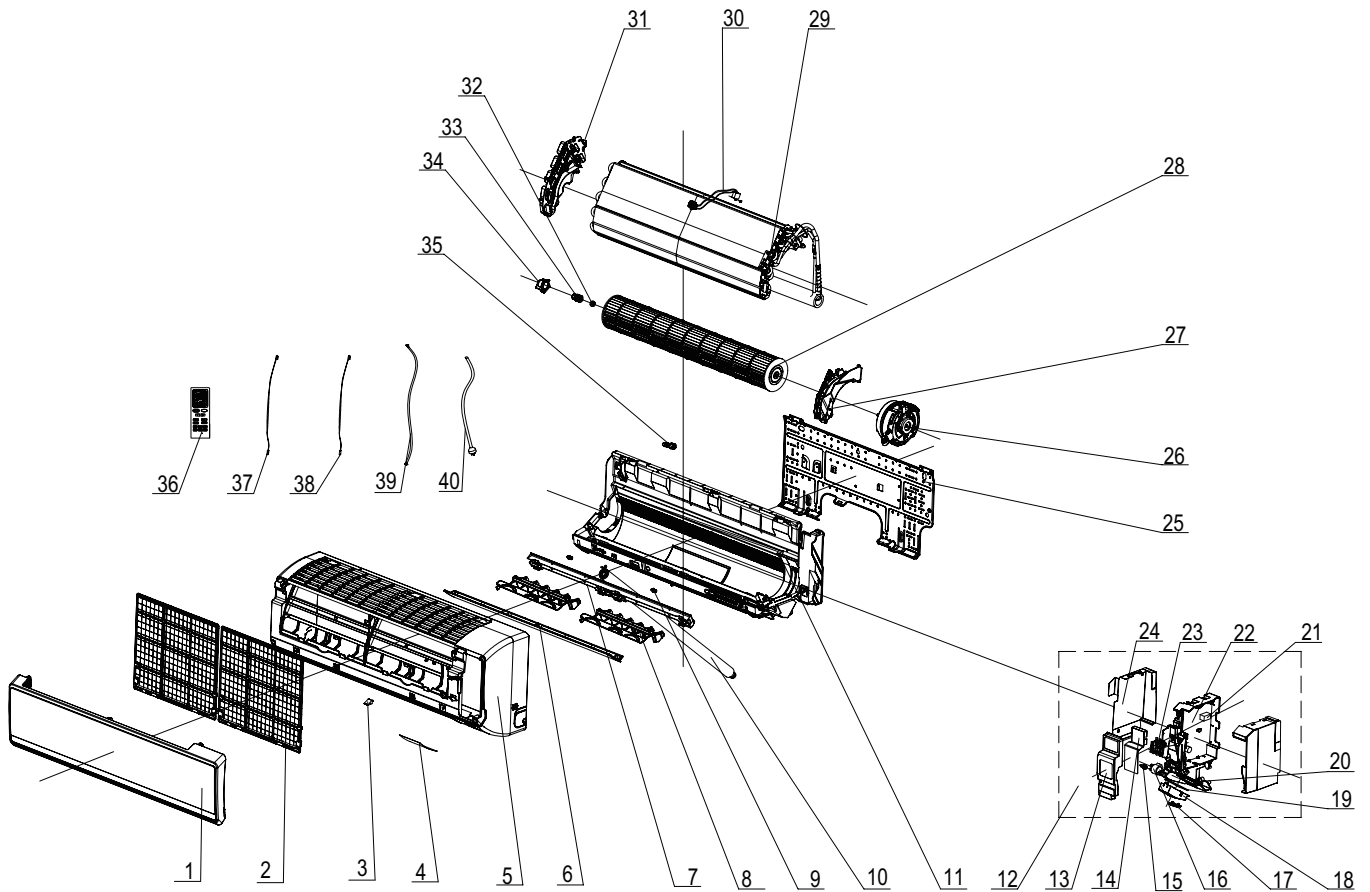

No.	Description	Part Code		Qty
		GWH09KF-K3DNA6G/I (Cold Plasma)	GWH12KF-K3DNA6G/I (Cold Plasma)	
		Product Code	Product Code	
		CB146N36200	CB146N36100	
1	Front Panel	20012443	20012443	1
2	Filter Sub-Assy	1112208201	1112208201	2
3	Screw Cover	24252019	24252019	1
4	Membrane	63062017	63062017	1
5	Front Case Assy	2001237501	2001237501	1
6	Guide Louver	10512119	10512119	1
7	Helicoid Tongue	26112486	26112486	1
8	Air Louver	10512160	10512160	2
9	Shaft of Guide Louver	1054202001	1054202001	2
10	Drainage Pipe Sub-assy	0523204101	0523204101	1
11	Rear Case assy	2220229501	2220229501	1
12	Electric Box Assy	10000201391	10000201392	1
13	Electric Box Cover	20122106	20122106	1
14	Shield Cover	01592076	01592076	1
15	Crank	73012005	73012005	1
16	Step Motor	1521210701	1521210701	1
17	Indicator Light Cover	22242084	22242084	1
18	Indicator Shield Cover	22242083	22242083	1
19	Display Board	30568112	30568112	1
20	Electric Box	20112086	20112086	1
21	Capacitor CBB61	3301000213	3301000213	1
22	Main Board	30138000407	30138000407	1
23	Terminal Board	42011233	42011233	1
24	Shield Cover	01592074	01592076	1
25	Wall Mounting Frame	0125201801A	0125201801A	1
26	Fan Motor	15012141	15012141	1
27	Motor Press Plate	26112191	26112191	1
28	Cross Flow Fan	10352423	10352423	1
29	Evaporator Assy	01002957	01002958	1
30	Cold Plasma Generator	1114001602	1114001602	1
31	Evaporator Support	24212108	24212108	1
32	Fan Bearing	76512210	76512210	1
33	Damping Washer Sub-assy	76512011	76512011	1
34	Axile Bush Sub-assy	10542024	10542024	1
35	Pipe Plug (Outlet)	76712020	76712020	1
36	Remote Controller	305100611	305100611	1
37	Temperature Sensor	390000453	390000453	1
38	Temperature Sensor	39000305	39000305	1
39	Connecting Cable	400204056	400204056	0
40	Power Cord	/	/	/

Above data is subject to change without notice.

11. Removal Procedure



Caution: discharge the refrigerant completely before removal.

Removal Procedure of Indoor Unit

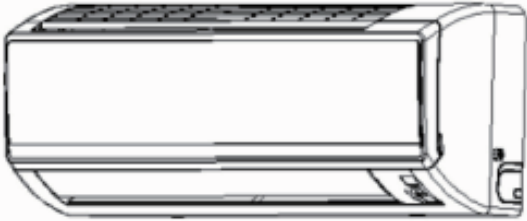
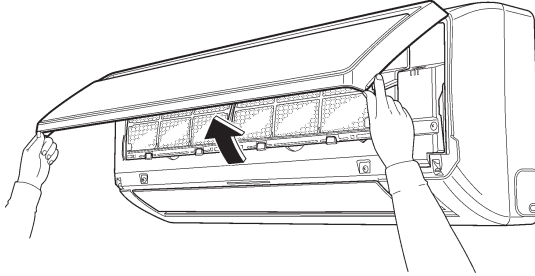
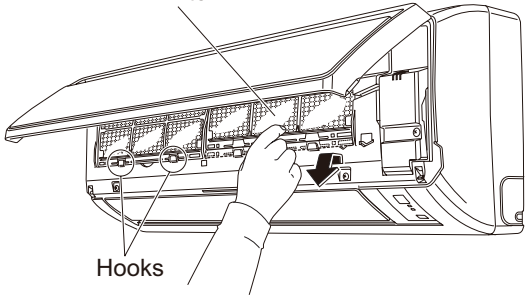
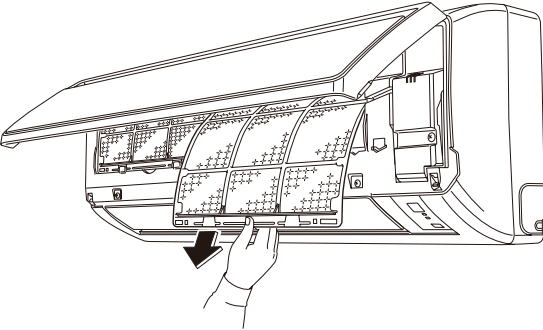
Steps	Procedure	Points
1. External features		<ul style="list-style-type: none"> ■ If ON/OFF button is kept pushing for 5 seconds, a forced cooling operation will be carried out for approx. 15 minutes.
2. Removing air filters	<p data-bbox="110 912 462 1043">a Pull protrusions on left and right sides of panel with fingers and open front grille all the way.</p>  <p data-bbox="110 1174 462 1273">b Lift center section of air filter and disengage hooks.</p>  <p data-bbox="110 1622 462 1688">c Remove air filter by pulling forward.</p> 	<ul style="list-style-type: none"> ■ Left and right filters are interchangeable. ■ To re-install, insert air filter along the guide.

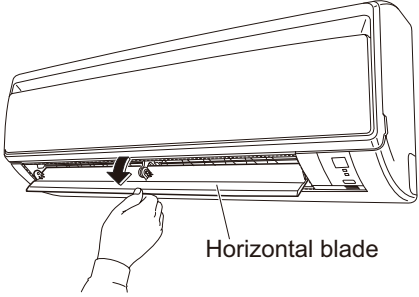
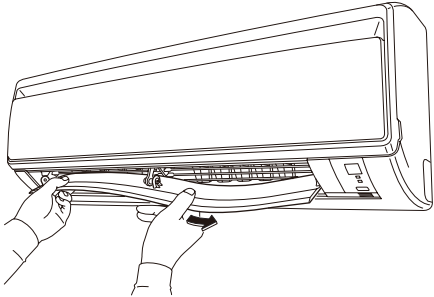
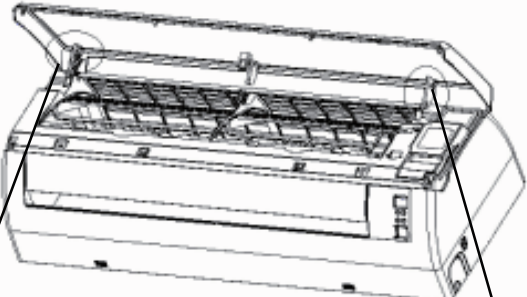
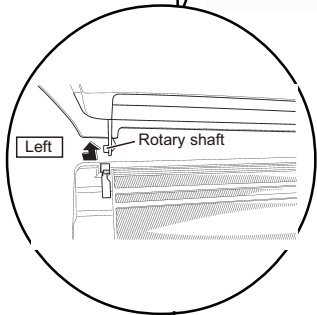
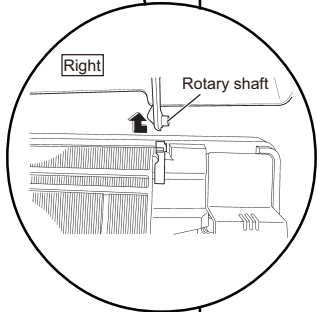
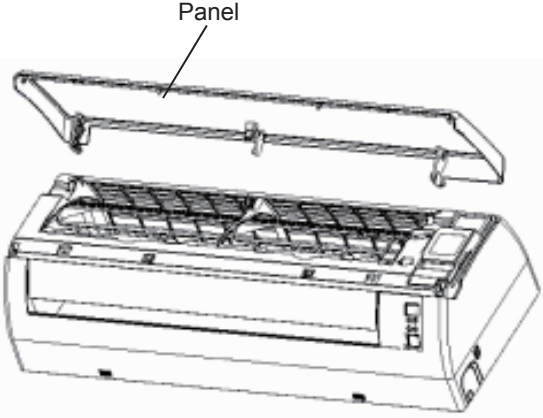
Steps	Procedure	Points
3. Remove panel		
a	<p>Pull down horizontal blade by pulling forward.</p>  <p>Horizontal blade</p>	<p>Support the front panel by one hand, while remove the rotation axis at the upper center by the other hand.</p>
b	<p>Remove horizontal blade by pulling forward.</p> 	<p>■ And pull out the front panel forward to remove.</p>
c	<p>Hook a finger onto the projection part provided on the both sides of the unit's panel and open up the panel to the position higher than it will stop.</p>   	<p>■ Left and right filters are interchangeable.</p> <p>■ To re-install, insert air filter along the guide.</p>
d	<p>Remove the front panel from the unit.</p>  <p>Panel</p>	

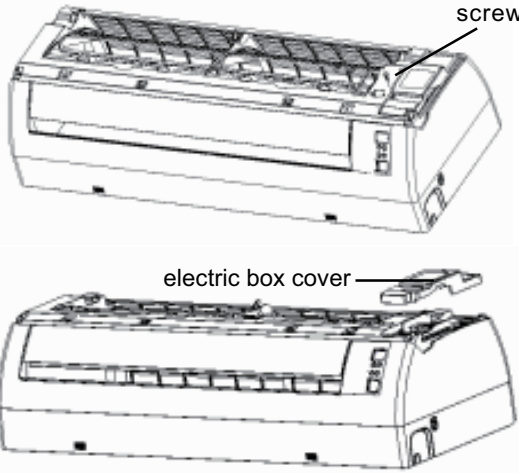
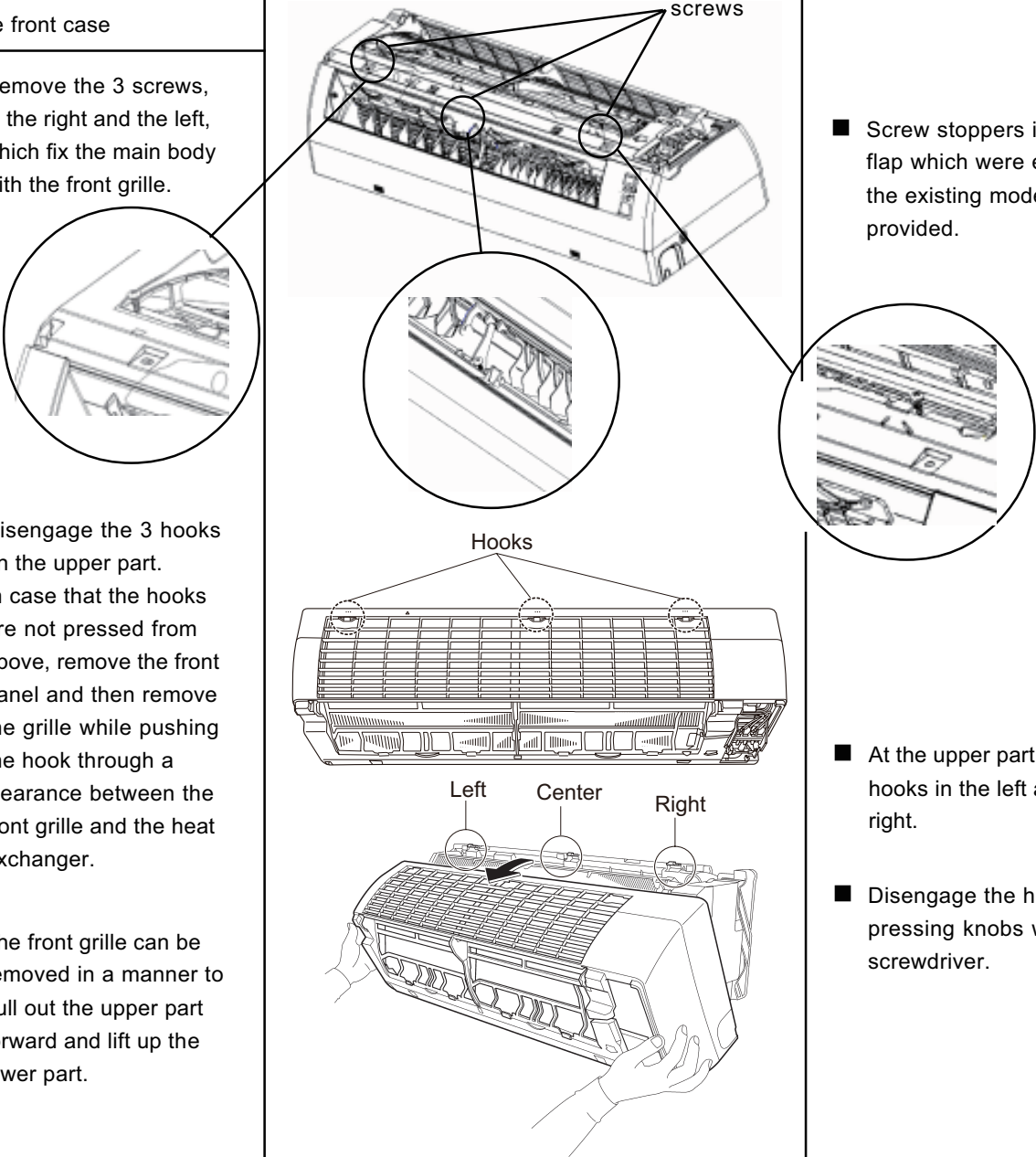
Steps	Procedure	Points
<p>4. Remove electric box cover</p>	<p>Remove a electric box cover mounting screw. Open electric box cover upward.</p> 	<ul style="list-style-type: none"> ■ A switch for field setting is not provided in particular.
<p>5. Remove front case</p> <p>a</p> <p>b</p> <p>c</p>	<p>Remove the 3 screws, in the right and the left, which fix the main body with the front grille.</p>  <p>Disengage the 3 hooks on the upper part. In case that the hooks are not pressed from above, remove the front panel and then remove the grille while pushing the hook through a clearance between the front grille and the heat exchanger.</p> <p>The front grille can be removed in a manner to pull out the upper part forward and lift up the lower part.</p>	<ul style="list-style-type: none"> ■ Screw stoppers inside the flap which were equipped in the existing models are not provided. ■ At the upper part there are 2 hooks in the left and the right. ■ Disengage the hooks by pressing knobs with a screwdriver.

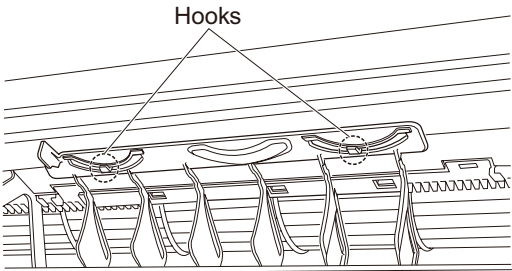
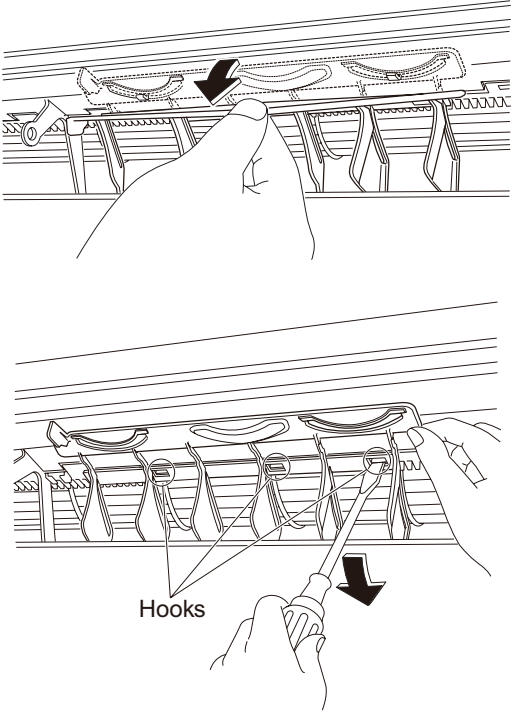
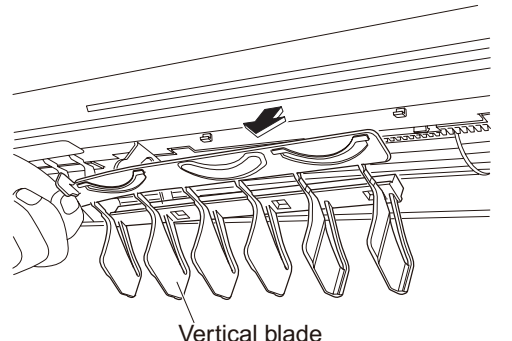
Steps	Procedure	Points
6. Remove the vertical blade		
a	<p>Unfasten the hooks at the upper 2 positions.</p> 	
b	<p>Unfasten the 3 hooks at the shaft mounting part by pressing them with a flat screwdriver.</p> 	<ul style="list-style-type: none"> ■ A set of vertical blade has 6 fins as on ASSY. (It is impossible to replace only one fin.) ■ The set of vertical blades is not marked for difference between right and left.
c	<p>Remove the vertical blade.</p> 	<ul style="list-style-type: none"> ■ Repeat the same procedure to remove the vertical blade on the other side.

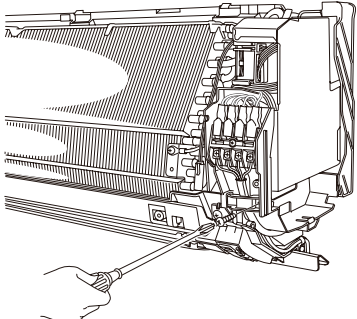
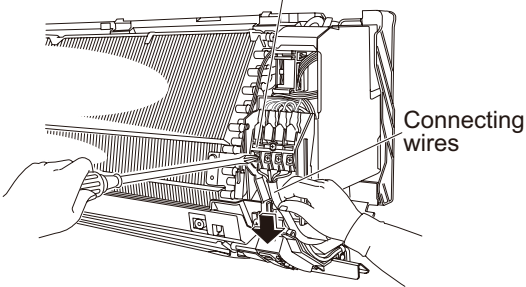
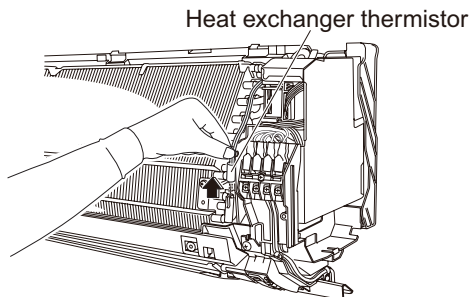
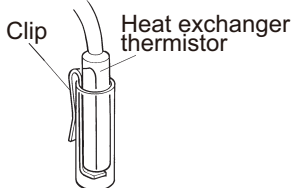
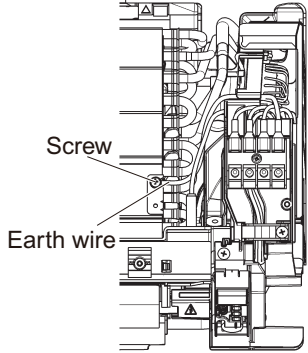
Steps	Procedure	Points
7. Remove electrical box		
a	<p>Disconnect the cable clamp</p> 	<ul style="list-style-type: none"> ■ Pay attention to the direction of the retainer of the thermistor so that the retainer will not touch the harness (same as the existing models.)
b	<p>Disconnect the connection wires.</p> 	
c	<p>Remove temperature sensor</p> 	<ul style="list-style-type: none"> ■ Take care not to lose the clip of thermistor. 
d	<p>Remove a screw on the terminal board.</p> 	<ul style="list-style-type: none"> ■ The electrical box can be removed instead of disengaging the terminal board.

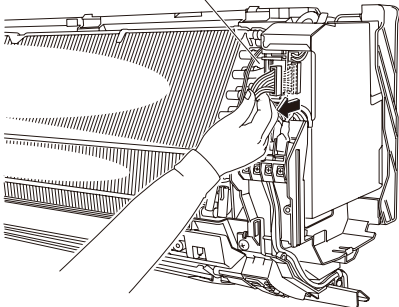
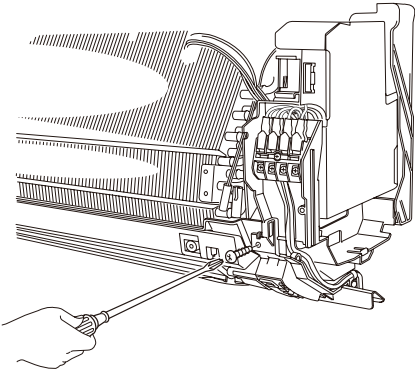
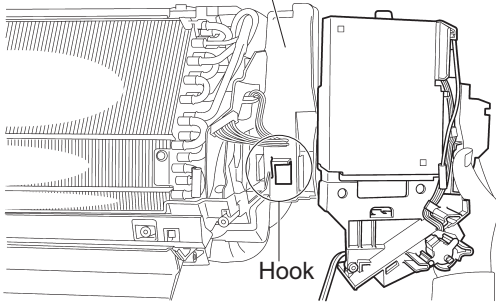
Steps		Procedure	Points
e	Remove fan motor Signal Wire	<p data-bbox="695 307 938 334">fan motor Signal Wire</p> 	
f	Remove a screw on the electrical box.		
g	Pull up the electrical box forward to remove.	<p data-bbox="760 1122 906 1148">Bottom frame</p> <p data-bbox="813 1415 873 1441">Hook</p> 	

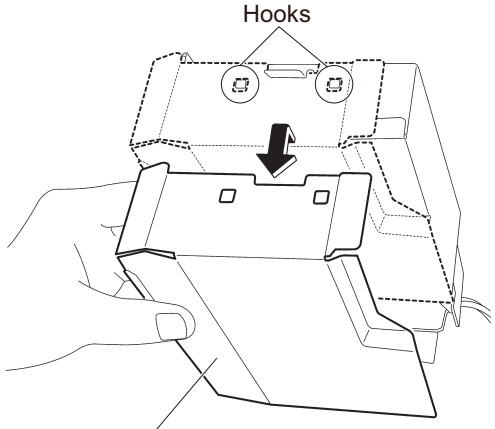
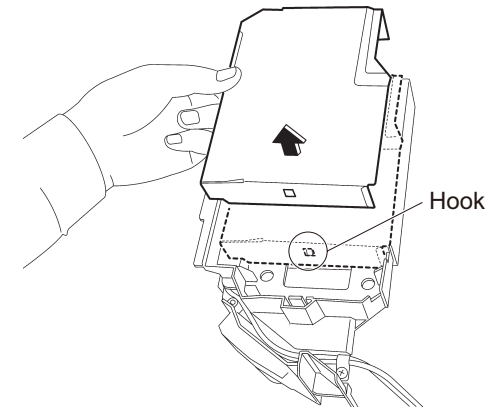
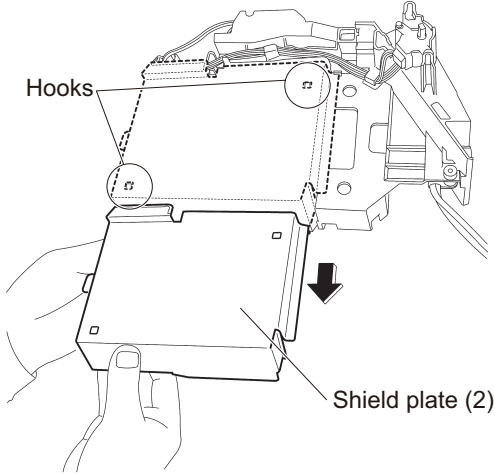
Steps	Procedure	Points	
8. Remove the shield plate and control PCB			
a	Unfasten the hooks at the upper 2 positions of the shield plate.	<ul style="list-style-type: none"> Remove the electrical box according to the "Removal of Electrical Box". 	
	 <p style="text-align: center;">Hooks</p> <p style="text-align: center;">shield plate (1)</p>		
b	Unfasten the hook at the lower position, and remove the shield plate (1).		
	 <p style="text-align: right;">Hook</p>		
c	Lift the shield plate (2) and unfasten the 2 hooks.		
d	Slide the shield plate (2) and remove it.		
	 <p style="text-align: left;">Hooks</p> <p style="text-align: right;">Shield plate (2)</p>		

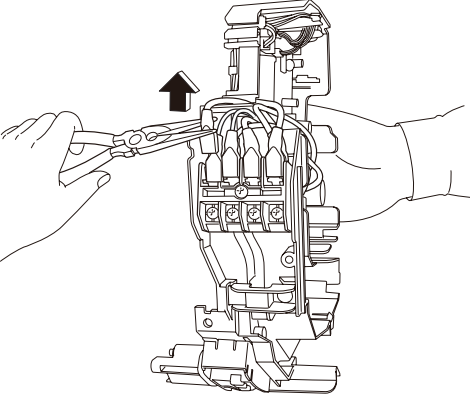
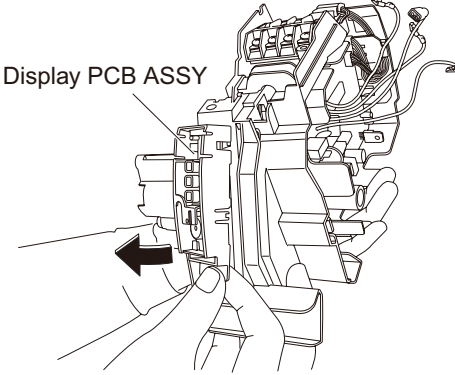
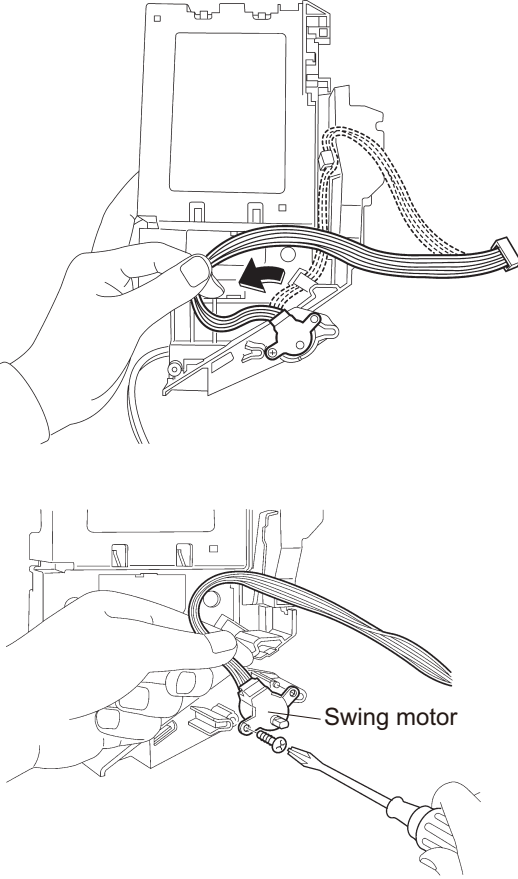
Steps		Procedure	Points
e	Take off wiring terminal		
f	Remove display PCB sub-Assy.		
g	Remove swing motor.		

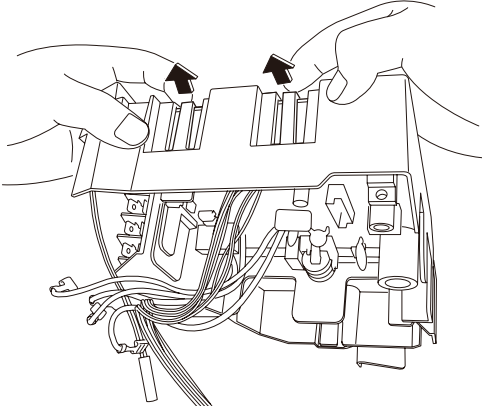
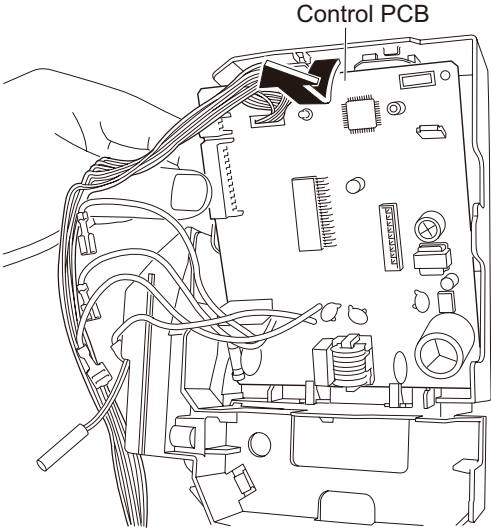
Steps		Procedure	Points
h	To remove the control PCB, unfasten the 2 hooks at the upper part from the rear side.		<ul style="list-style-type: none"> ■ The control PCB is integrated with the power supply PCB.
i	Lift up the upper part of the control PCB, and remove it.		

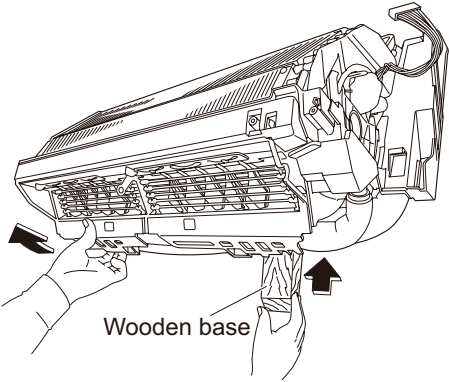
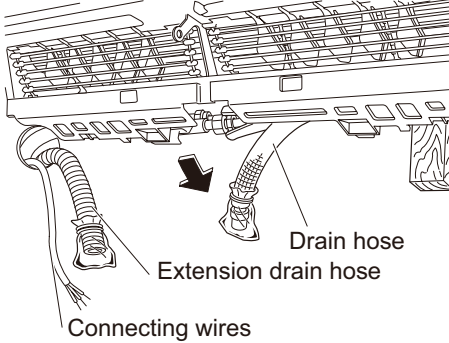
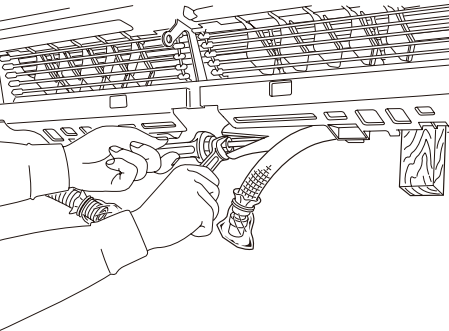
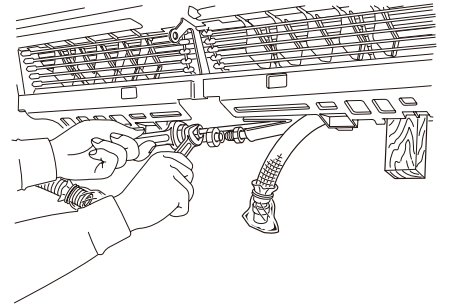
Steps	Procedure	Points
9. Remove the refrigerant piping		
a	<p>Lift the indoor unit by a wooden base.</p> 	<p>⚠ CAUTION</p> <p>If gas leaks, repair the spot of leaking, then collect all refrigerant from the unit. After conducting vacuum drying, recharge proper amount of refrigerant.</p>
b	<p>Place a plastic sheet under the drain pan as remaining drain may leak.</p> 	<p>⚠ CAUTION</p> <p>Do not contaminate any gas (including air) other than the specified refrigerant (R-410A) into refrigerant cycle. (Contaminating of air or other gas causes abnormal high pressure in refrigerating cycle, and this results in pipe breakage or personal injuries.)</p>
c	<p>Disconnect the flare nut for gas piping by 2 wrenches.</p> 	<ul style="list-style-type: none"> ■ Pay attention so that the residual water in the drain will not make the floor wet.
d	<p>Disconnect the flare nut for liquid piping by 2 wrenches.</p> 	<ul style="list-style-type: none"> ■ In case that a drain hose is buried inside a wall, remove it after the drain hose in the wall is pulled out. ■ Use two wrenches to disconnected pipes. ■ When disconnecting pipes, cover every nozzle with caps so as not to let dust and moisture in.

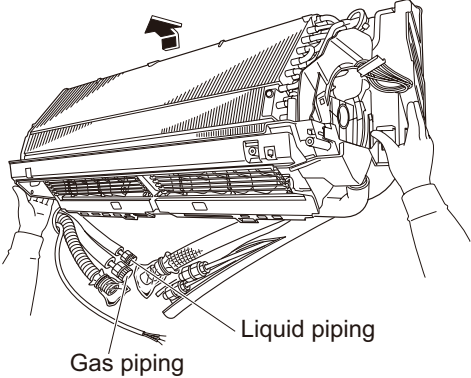
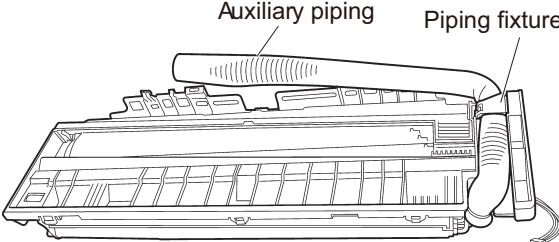
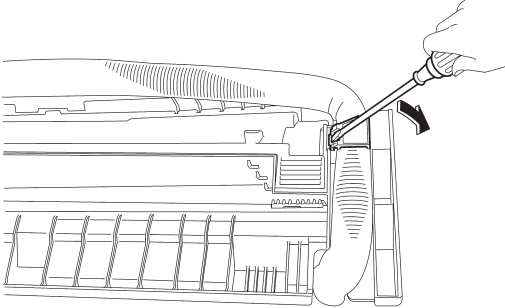
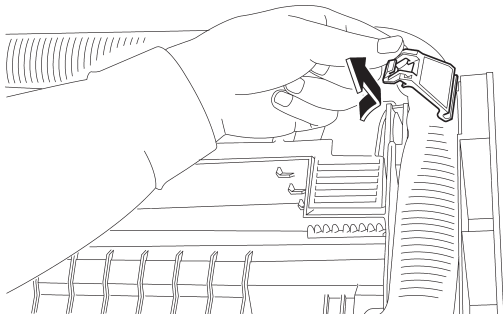
Steps	Procedure	Points
10. Remove evaporator assy		
a	<p>Remove the indoor unit from the installation plate.</p> 	<ul style="list-style-type: none">■ When the pipings are disconnected, protect the both openings from entering moisture.
b	<p>Release the hook of the piping fixture on the back of the unit.</p>   	

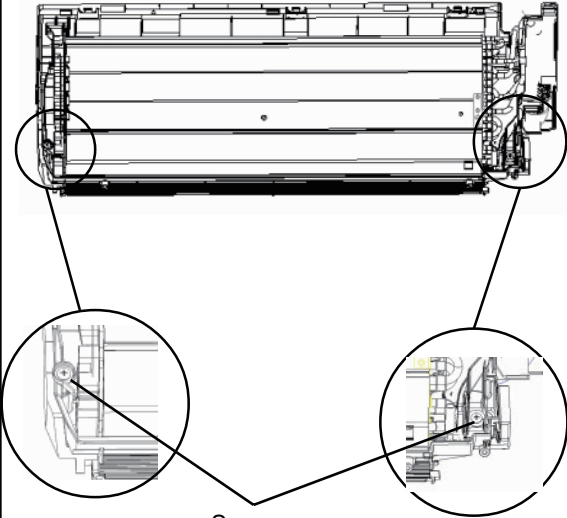
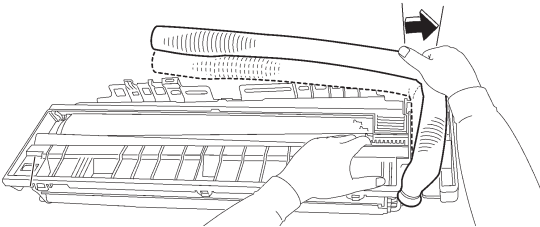
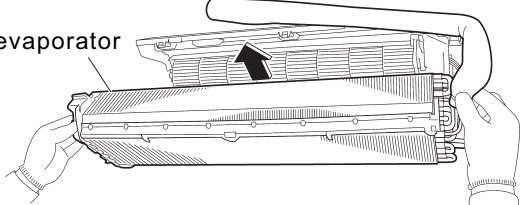
Steps	Procedure	Points
<p>c</p>	<p>Loosen the 2 screws, in the right and the left, which fix the evaporator assy.</p>  <p>Screws</p>	
<p>d</p>	<p>Widen the auxiliary piping to the extent of 10°~20°.</p>  <p>Auxiliary piping</p>	
<p>e</p>	<p>Pull the evaporator assy to the front side to undo the hooks completely, and then lift it.</p>  <p>evaporator</p>	

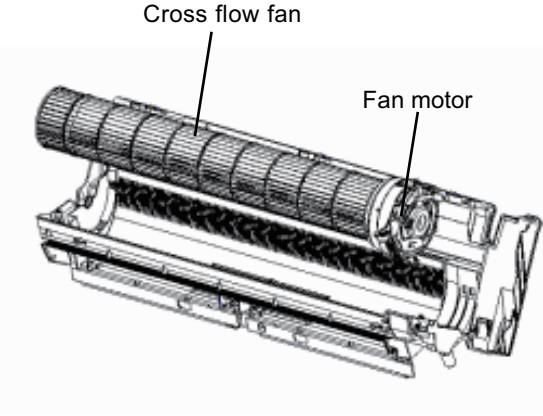
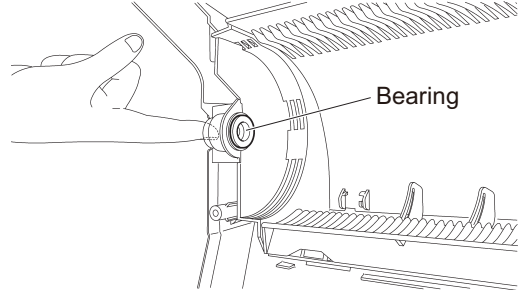
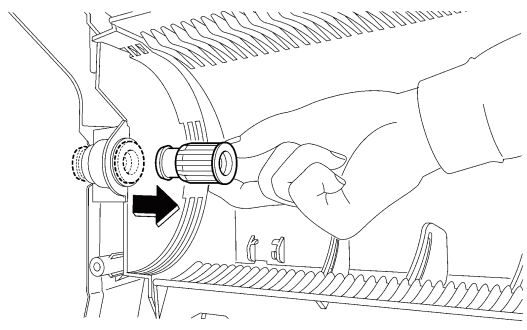
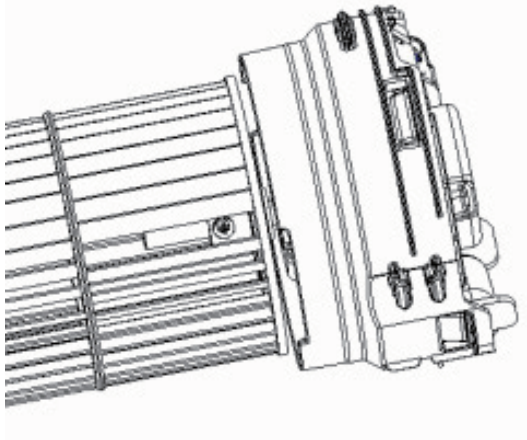
Steps	Procedure	Points
11. Remove cross flow fan and fan motor		
a	<p>Remove cross flow fan and fan motor.</p> 	
b	<p>Remove the rubber cushion of the bearing.</p>  	
c	<p>Remove the screws at the joint of the cross flow blade and the motor.</p> 	

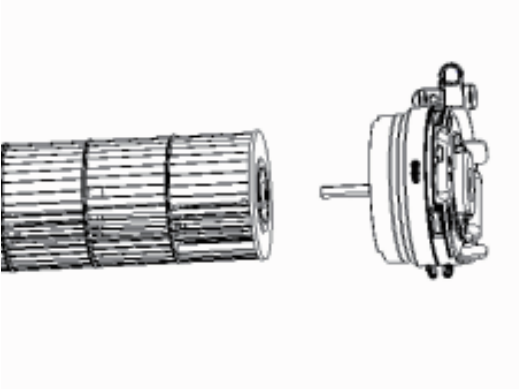
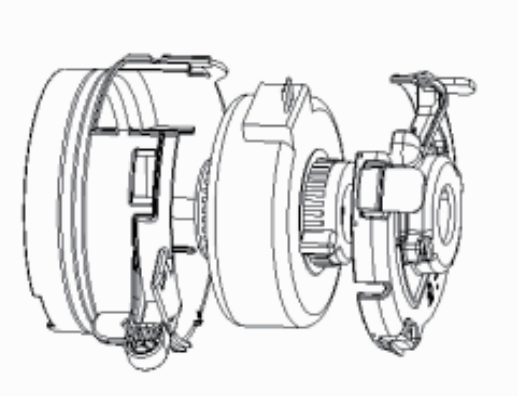
Steps	Procedure		Points
d	Take down the motor sub-assy.		
e	Remove fan motor.		

Appendix:

Appendix 1: Reference Sheet of Celsius and Fahrenheit

Conversion formula for Fahrenheit degree and Celsius degree: $T_f = T_c \times 1.8 + 32$

Set temperature

Fahrenheit display temperature (°F)	Fahrenheit (°F)	Celsius(°C)	Fahrenheit display temperature (°F)	Fahrenheit (°F)	Celsius(°C)	Fahrenheit display temperature (°F)	Fahrenheit (°F)	Celsius(°C)
61	60.8	16	69/70	69.8	21	78/79	78.8	26
62/63	62.6	17	71/72	71.6	22	80/81	80.6	27
64/65	64.4	18	73/74	73.4	23	82/83	82.4	28
66/67	66.2	19	75/76	75.2	24	84/85	84.2	29
68	68	20	77	77	25	86	86	30

Ambient temperature

Fahrenheit display temperature (°F)	Fahrenheit (°F)	Celsius(°C)	Fahrenheit display temperature (°F)	Fahrenheit (°F)	Celsius(°C)	Fahrenheit display temperature (°F)	Fahrenheit (°F)	Celsius(°C)
32/33	32	0	55/56	55.4	13	79/80	78.8	26
34/35	33.8	1	57/58	57.2	14	81	80.6	27
36	35.6	2	59/60	59	15	82/83	82.4	28
37/38	37.4	3	61/62	60.8	16	84/85	84.2	29
39/40	39.2	4	63	62.6	17	86/87	86	30
41/42	41	5	64/65	64.4	18	88/89	87.8	31
43/44	42.8	6	66/67	66.2	19	90	89.6	32
45	44.6	7	68/69	68	20	91/92	91.4	33
46/47	46.4	8	70/71	69.8	21	93/94	93.2	34
48/49	48.2	9	72	71.6	22	95/96	95	35
50/51	50	10	73/74	73.4	23	97/98	96.8	36
52/53	51.8	11	75/76	75.2	24	99	98.6	37
54	53.6	12	77/78	77	25			

Appendix 2: Configuration of Connection Pipe

- Standard length of connection pipe
 - 5m, 7.5m, 8m.
- Min. length of connection pipe is 3m.
- Max. length of connection pipe and max. high difference.
- The additional refrigerant oil and refrigerant charging required after prolonging connection pipe
 - After the length of connection pipe is prolonged for 10m at the basis of standard length, you should add 5ml of refrigerant oil for each additional 5m of connection pipe.
 - The calculation method of additional refrigerant charging amount (on the basis of liquid pipe):

Cooling capacity	Max length of connection pipe	Max height difference
5000 Btu/h(1465 W)	15 m	5 m
7000 Btu/h(2051 W)	15 m	5 m
9000 Btu/h(2637 W)	15 m	10 m
12000 Btu/h(3516 W)	20 m	10 m
18000 Btu/h(5274 W)	25 m	10 m
24000 Btu/h(7032 W)	25 m	10 m
28000 Btu/h(8204 W)	30 m	10 m
36000 Btu/h(10548 W)	30 m	20 m
42000 Btu/h(12306 W)	30 m	20 m
48000 Btu/h(14064 W)	30 m	20 m

- When the length of connection pipe is above 5m, add refrigerant according to the prolonged length of liquid pipe. The additional refrigerant charging amount per meter is different according to the diameter of liquid pipe. See the following sheet.
- Additional refrigerant charging amount = prolonged length of liquid pipe X additional refrigerant charging amount per meter

Additional refrigerant charging amount for R22, R407C, R410A and R134a			
Diameter of connection pipe		Outdoor unit throttle	
Liquid pipe(mm)	Gas pipe(mm)	Cooling only(g/m)	Cooling and heating(g/m)
Φ6	Φ9.5 or Φ12	15	20
Φ6 or Φ9.5	Φ16 or Φ19	15	20
Φ12	Φ19 or Φ22.2	30	120
Φ16	Φ25.4 or Φ31.8	60	120
Φ19	/	250	250
Φ22.2	/	350	350

Appendix 3: Pipe Expanding Method

⚠ Note:

Improper pipe expanding is the main cause of refrigerant leakage. Please expand the pipe according to the following steps:

A: Cut the pip

- Confirm the pipe length according to the distance of indoor unit and outdoor unit.
- Cut the required pipe with pipe cutter.

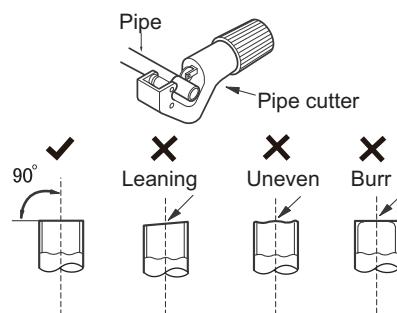

B: Remove the burrs

- Remove the burrs with shaper and prevent the burrs from getting into the pipe.

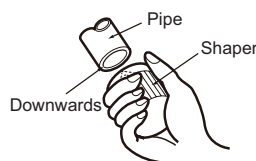

C: Put on suitable insulating pipe

D: Put on the union nut

- Remove the union nut on the indoor connection pipe and outdoor valve; install the union nut on the pipe.

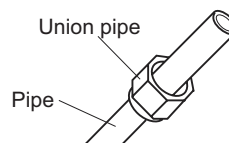

E: Expand the port

- Expand the port with expander.

⚠ Note:

- "A" is different according to the diameter, please refer to the sheet below:

Outer diameter(mm)	A(mm)	
	Max	Min
Φ6 - 6.35 (1/4")	1.3	0.7
Φ9.52 (3/8")	1.6	1.0
Φ12 - 12.70 (1/2")	1.8	1.0
Φ16 - 15.88 (5/8")	2.4	2.2

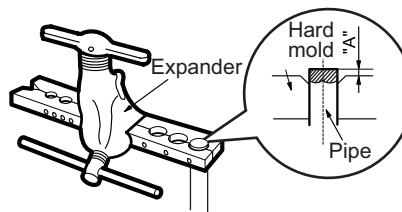

F: Inspection

- Check the quality of expanding port. If there is any blemish, expand the port again according to the steps above.

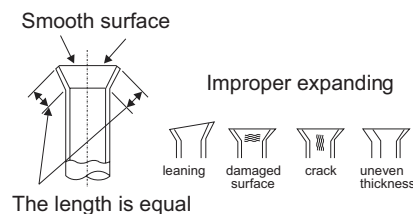

Appendix 4: List of Resistance for Temperature Sensor

Resistance Table of Ambient Temperature Sensor for Indoor and Outdoor (15K)

Temp(°C)	Resistance(kΩ)	Temp(°C)	Resistance(kΩ)	Temp(°C)	Resistance(kΩ)	Temp(°C)	Resistance(kΩ)
-19	138.1	20	18.75	59	3.848	98	1.071
-18	128.6	21	17.93	60	3.711	99	1.039
-17	121.6	22	17.14	61	3.579	100	1.009
-16	115	23	16.39	62	3.454	101	0.98
-15	108.7	24	15.68	63	3.333	102	0.952
-14	102.9	25	15	64	3.217	103	0.925
-13	97.4	26	14.36	65	3.105	104	0.898
-12	92.22	27	13.74	66	2.998	105	0.873
-11	87.35	28	13.16	67	2.896	106	0.848
-10	82.75	29	12.6	68	2.797	107	0.825
-9	78.43	30	12.07	69	2.702	108	0.802
-8	74.35	31	11.57	70	2.611	109	0.779
-7	70.5	32	11.09	71	2.523	110	0.758
-6	66.88	33	10.63	72	2.439	111	0.737
-5	63.46	34	10.2	73	2.358	112	0.717
-4	60.23	35	9.779	74	2.28	113	0.697
-3	57.18	36	9.382	75	2.206	114	0.678
-2	54.31	37	9.003	76	2.133	115	0.66
-1	51.59	38	8.642	77	2.064	116	0.642
0	49.02	39	8.297	78	1.997	117	0.625
1	46.6	40	7.967	79	1.933	118	0.608
2	44.31	41	7.653	80	1.871	119	0.592
3	42.14	42	7.352	81	1.811	120	0.577
4	40.09	43	7.065	82	1.754	121	0.561
5	38.15	44	6.791	83	1.699	122	0.547
6	36.32	45	6.529	84	1.645	123	0.532
7	34.58	46	6.278	85	1.594	124	0.519
8	32.94	47	6.038	86	1.544	125	0.505
9	31.38	48	5.809	87	1.497	126	0.492
10	29.9	49	5.589	88	1.451	127	0.48
11	28.51	50	5.379	89	1.408	128	0.467
12	27.18	51	5.197	90	1.363	129	0.456
13	25.92	52	4.986	91	1.322	130	0.444
14	24.73	53	4.802	92	1.282	131	0.433
15	23.6	54	4.625	93	1.244	132	0.422
16	22.53	55	4.456	94	1.207	133	0.412
17	21.51	56	4.294	95	1.171	134	0.401
18	20.54	57	4.139	96	1.136	135	0.391
19	19.63	58	3.99	97	1.103	136	0.382

Resistance Table of Tube Temperature Sensors for Indoor and Outdoor (20K)

Temp(°C)	Resistance(kΩ)	Temp(°C)	Resistance(kΩ)	Temp(°C)	Resistance(kΩ)	Temp(°C)	Resistance(kΩ)
-19	181.4	20	25.01	59	5.13	98	1.427
-18	171.4	21	23.9	60	4.948	99	1.386
-17	162.1	22	22.85	61	4.773	100	1.346
-16	153.3	23	21.85	62	4.605	101	1.307
-15	145	24	20.9	63	4.443	102	1.269
-14	137.2	25	20	64	4.289	103	1.233
-13	129.9	26	19.14	65	4.14	104	1.198
-12	123	27	18.13	66	3.998	105	1.164
-11	116.5	28	17.55	67	3.861	106	1.131
-10	110.3	29	16.8	68	3.729	107	1.099
-9	104.6	30	16.1	69	3.603	108	1.069
-8	99.13	31	15.43	70	3.481	109	1.039
-7	94	32	14.79	71	3.364	110	1.01
-6	89.17	33	14.18	72	3.252	111	0.983
-5	84.61	34	13.59	73	3.144	112	0.956
-4	80.31	35	13.04	74	3.04	113	0.93
-3	76.24	36	12.51	75	2.94	114	0.904
-2	72.41	37	12	76	2.844	115	0.88
-1	68.79	38	11.52	77	2.752	116	0.856
0	65.37	39	11.06	78	2.663	117	0.833
1	62.13	40	10.62	79	2.577	118	0.811
2	59.08	41	10.2	80	2.495	119	0.77
3	56.19	42	9.803	81	2.415	120	0.769
4	53.46	43	9.42	82	2.339	121	0.746
5	50.87	44	9.054	83	2.265	122	0.729
6	48.42	45	8.705	84	2.194	123	0.71
7	46.11	46	8.37	85	2.125	124	0.692
8	43.92	47	8.051	86	2.059	125	0.674
9	41.84	48	7.745	87	1.996	126	0.658
10	39.87	49	7.453	88	1.934	127	0.64
11	38.01	50	7.173	89	1.875	128	0.623
12	36.24	51	6.905	90	1.818	129	0.607
13	34.57	52	6.648	91	1.736	130	0.592
14	32.98	53	6.403	92	1.71	131	0.577
15	31.47	54	6.167	93	1.658	132	0.563
16	30.04	55	5.942	94	1.609	133	0.549
17	28.68	56	5.726	95	1.561	134	0.535
18	27.39	57	5.519	96	1.515	135	0.521
19	26.17	58	5.32	97	1.47	136	0.509

Resistance Table of Discharge Temperature Sensor for Outdoor (50K)

Temp(°C)	Resistance(kΩ)	Temp(°C)	Resistance(kΩ)	Temp(°C)	Resistance(kΩ)	Temp(°C)	Resistance(kΩ)
-29	853.5	10	98	49	18.34	88	4.75
-28	799.8	11	93.42	50	17.65	89	4.61
-27	750	12	89.07	51	16.99	90	4.47
-26	703.8	13	84.95	52	16.36	91	4.33
-25	660.8	14	81.05	53	15.75	92	4.20
-24	620.8	15	77.35	54	15.17	93	4.08
-23	580.6	16	73.83	55	14.62	94	3.96
-22	548.9	17	70.5	56	14.09	95	3.84
-21	516.6	18	67.34	57	13.58	96	3.73
-20	486.5	19	64.33	58	13.09	97	3.62
-19	458.3	20	61.48	59	12.62	98	3.51
-18	432	21	58.77	60	12.17	99	3.41
-17	407.4	22	56.19	61	11.74	100	3.32
-16	384.5	23	53.74	62	11.32	101	3.22
-15	362.9	24	51.41	63	10.93	102	3.13
-14	342.8	25	49.19	64	10.54	103	3.04
-13	323.9	26	47.08	65	10.18	104	2.96
-12	306.2	27	45.07	66	9.83	105	2.87
-11	289.6	28	43.16	67	9.49	106	2.79
-10	274	29	41.34	68	9.17	107	2.72
-9	259.3	30	39.61	69	8.85	108	2.64
-8	245.6	31	37.96	70	8.56	109	2.57
-7	232.6	32	36.38	71	8.27	110	2.50
-6	220.5	33	34.88	72	7.99	111	2.43
-5	209	34	33.45	73	7.73	112	2.37
-4	198.3	35	32.09	74	7.47	113	2.30
-3	199.1	36	30.79	75	7.22	114	2.24
-2	178.5	37	29.54	76	7.00	115	2.18
-1	169.5	38	28.36	77	6.76	116	2.12
0	161	39	27.23	78	6.54	117	2.07
1	153	40	26.15	79	6.33	118	2.02
2	145.4	41	25.11	80	6.13	119	1.96
3	138.3	42	24.13	81	5.93	120	1.91
4	131.5	43	23.19	82	5.75	121	1.86
5	125.1	44	22.29	83	5.57	122	1.82
6	119.1	45	21.43	84	5.39	123	1.77
7	113.4	46	20.6	85	5.22	124	1.73
8	108	47	19.81	86	5.06	125	1.68
9	102.8	48	19.06	87	4.90	126	1.64

JF00302520



GREE ELECTRIC APPLIANCES, INC. OF ZHUHAI

Add: West Jinji Rd, Qianshan, Zhuhai, Guangdong, China 519070

Tel: (+86-756) 8522218 Fax: (+86-756) 8669426

Email: gree@gree.com.cn [Http://www.gree.com](http://www.gree.com)

HONG KONG GREE ELECTRIC APPLIANCES SALES LIMITED

Add: Unit 2612, 26/F., Miramar Tower 132 Nathan Road, TST, Kowloon, HK

Tel: (852) 31658898 Fax: (852) 31651029

For product improvement, specifications and appearance in this manual are subject to change without prior notice.